

Rider's Manual

F 800 R



BMW Motorrad



The Ultimate
Riding Machine

Motorcycle data/dealership details

Motorcycle data

Model

Vehicle identification number

Colour code

Date of first registration

Registration number

Dealership details

Person to contact in Service department

Ms/Mr

Phone number

Dealership address/phone number (company stamp)

Details described or illustrated in this booklet may differ from the motorcycle's actual specification as purchased, the accessories fitted or the national-market specification. No claims will be entertained as a result of such discrepancies.

Dimensions, weights, fuel consumption and performance data are quoted to the customary tolerances.

The right to modify designs, equipment and accessories is reserved.

Errors and omissions excepted.

© 2010 BMW Motorrad

Not to be reproduced either wholly or in part without written permission from BMW Motorrad, After Sales.

Printed in Germany.

Important data for refuelling

Fuel

Recommended fuel grade	Super unleaded 95 ROZ/RON 89 AKI
------------------------	--

Usable fuel capacity	approx. 16 l
----------------------	--------------

Reserve fuel	approx. 2 l
--------------	-------------

Tyre pressures

Tyre pressure, front	2.5 bar, Tyre cold
----------------------	--------------------

Tyre pressure, rear	2.9 bar, Tyre cold
---------------------	--------------------

BMW recommends 

Order No.: 01 41 8 521 171
06.2010, 3rd edition

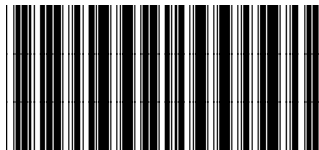

Welcome to BMW

We congratulate you on your choice of a motorcycle from BMW and welcome you to the community of BMW riders.

Familiarise yourself with your new motorcycle so that you can ride it safely and confidently in all traffic situations.

Please read this Rider's Manual carefully before starting to use your new BMW motorcycle. It contains important information on how to operate the controls and how to make the best possible use of all your BMW's technical features.

In addition, it contains information on maintenance and care to help you maintain your motorcycle's reliability and safety, as well as its value.

If you have questions concerning your motorcycle, your authorised

BMW Motorrad dealer will gladly provide advice and assistance.

We hope that you will enjoy riding your BMW and that all your journeys will be pleasant and safe.

BMW Motorrad.

Table of Contents

You can also consult the index at the end of this Rider's Manual if you want to find a particular topic or item of information.

1 General instructions 5

Overview 6

Abbreviations and symbols 6

Equipment 7

Technical data 7

Currency 7

2 General views 9

General view, left side 11

General view, right side 13

Underneath the seat 14

Underneath the centre trim panel 15

Handlebar fitting, left 16

Handlebar fitting, right 17

Instrument panel 18

3 Status indicators 21

Multifunction display 22

Meaning of symbols 23

Fuel capacity 23

Warning and telltale lights 24

Service-due indicator 25

Kilometres travelled after fuel down to reserve 25

Ambient temperature 26

Tyre pressures 26

Warnings 27

4 Operation 37

Ignition switch and steering lock 38

Electronic immobiliser EWS 39

Clock 39

Reading 40

Stopwatch 41

Lights 43

Turn indicators 44

Hazard warning flashers 44

Emergency off switch (kill switch) 45

Grip heating 45

Clutch 46

Brakes 46

Mirrors 47

Spring preload 48

Damping 49

Tyres 49

Headlight 50

Seat 51

5 Riding 53

Safety instructions 54

Checklist 56

Starting 56

Running in 58

speed 59

Brakes 60

Parking your motorcycle 61

Refuelling 62

Securing motorcycle for transportation 63

6 Engineering details	65	Battery	107	Dimensions	126
Brake system with BMW		9 Care	111	Weights	127
Motorrad ABS.....	66	Care products	112	Riding specifications	127
Tyre pressure monitoring		Washing motorcycle.....	112	11 Service	129
RDC.....	68	Cleaning easily damaged		BMW Motorrad service....	130
7 Accessories	71	components.....	112	BMW Motorrad service	
General instructions	72	Paint care	113	quality	130
Power sockets	72	Protective wax coating	114	BMW Motorrad mobility	
Luggage	73	Laying up motorcycle	114	services - roadside assist-	
Case	73	Restoring motorcycle to		ance.....	130
topcase	76	use	114	BMW Motorrad service	
8 Maintenance	79	10 Technical data	115	network	131
General instructions	80	troubleshooting chart.....	116	Maintenance work.....	131
Toolkit.....	80	Threaded fasteners	117	Confirmation of mainten-	
Engine oil	81	Engine	119	ance work	132
Brake system	82	Fuel	120	Confirmation of service....	137
Coolant.....	87	Engine oil	120		
Clutch	87	Clutch	121		
Rims and tyres	88	Transmission	121		
Chain.....	89	Rear-wheel drive	122		
Wheels	91	Running gear.....	122		
Front-wheel stand.....	97	Brakes	123		
Bulbs	98	Wheels and tyres.....	123		
Body panels	104	Electrics	124		
Jump starting	106	Frame	126		

General instructions

Overview	6
Abbreviations and symbols	6
Equipment	7
Technical data	7
Currency	7

Overview

Chapter 2 of this Rider's Manual will provide you with an initial overview of your motorcycle. All maintenance and repair work on the motorcycle is documented in Chapter 11. This record of the maintenance work you have had performed on your motorcycle is a precondition for generous treatment of goodwill claims.

When the time comes to sell your BMW, please remember to hand over this Rider's Manual; it is an important part of the motorcycle.

Abbreviations and symbols



Indicates warnings that you must comply with for reasons of your safety and the safety of others, and to protect your motorcycle against damage.



Specific instructions on how to operate, control, adjust or look after items of equipment on the motorcycle.



Indicates the end of an item of information.



Instruction.



Result of an activity.



Reference to a page with more detailed information.



Indicates the end of a passage relating to specific accessories or items of equipment.



Tightening torque.



Item of technical data.

OE

Optional extra

The motorcycles are assembled complete with all the BMW optional extras originally ordered.

OA

Optional accessory

You can obtain optional accessories through your authorised BMW Motorrad dealer; optional accessories have to be retrofitted to the motorcycle.

EWS

Electronic immobiliser.

DWA

Anti-theft alarm (Diebstahlwarnanlage)

ABS

Anti-lock brake system

RDC

Tyre pressure monitoring (ReifenDruck-Control)

Equipment

When you ordered your BMW motorcycle, you chose various items of custom equipment. This Rider's Manual describes optional extras (OE) offered by BMW and selected optional accessories (OA). This explains why the manual may also contain descriptions of equipment which you have not ordered. Please note, too, that your motorcycle might not be exactly as illustrated in this manual on account of country-specific differences. If your BMW was supplied with equipment not described in this Rider's Manual, you will find these features described in separate manuals.

Technical data

All dimensions, weights and power ratings stated in this Rider's Manual are quoted to the standards and comply with the tolerance requirements of the Deutsches Institut für Normung e.V. (DIN). Versions for individual countries may differ.

Currency

The high safety and quality standards of BMW motorcycles are maintained by constant development work on designs, equipment and accessories. Because of this, your motorcycle may differ from the information supplied in the Rider's Manual. Nor can BMW Motorrad entirely rule out errors and omissions. We hope you will appreciate that no claims can be entertained on the basis of the data, illustrations or descriptions in this manual.

General instructions

∞



General views

General view, left side.....	11
General view, right side	13
Underneath the seat	14
Underneath the centre trim panel	15
Handlebar fitting, left.....	16
Handlebar fitting, right	17
Instrument panel.....	18



General view, left side

- 1 Payload table (on left on steering-head bearing)
- 2 Seat lock (→ 51)
- 3 Engine-oil filler neck and oil dipstick (→ 81)

2

11

General views



General view, right side

- 1 Fuel filler neck (➡ 62)
- 2 Adjuster, spring preload (➡ 48)
- 3 VIN, type plate (on steering-head bearing)
- 4 Brake-fluid reservoir, front (➡ 85)
- 5 Coolant level indicator (behind side panel) (➡ 87)
- 6 Power socket (➡ 72)
- 7 Adjuster for damping characteristic (➡ 49)
- 8 Brake-fluid reservoir, rear (➡ 86)

Underneath the seat

- 1 Tool for adjusting spring preload (→ 48)
- 2 Standard toolkit (→ 80)
- 3 Rider's Manual
- 4 Storage
– with first-aid kit ^{OA}
Location of the first-aid kit
- 5 Table of tyre pressures
- 6 Storage
– with service toolkit ^{OA}
Location of the service toolkit (→ 80)

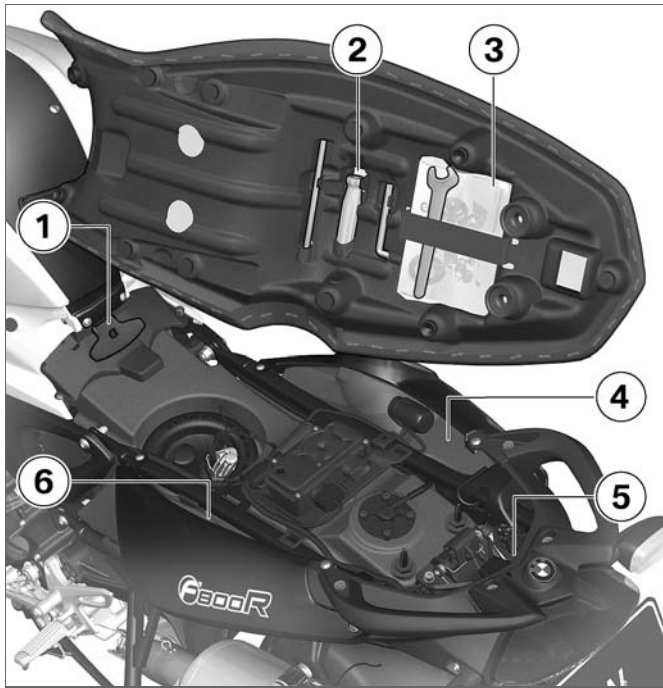

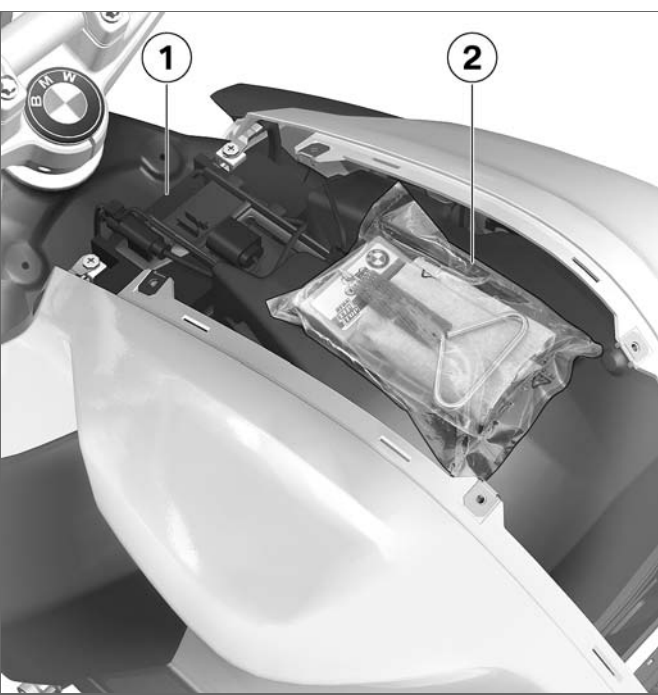

Underneath the centre trim panel

- 1 Battery (➡ 107)
- 2 Stowage
– with tyre repair kit^{OA}
Location of the tyre repair kit

Handlebar fitting, left

- 1 High-beam headlight and headlight flasher (➔ 43)
- 2 Selecting reading in extended area (➔ 40)
- 3 Hazard warning flashers (➔ 44)
- 4 Operation of the flashing turn indicators (➔ 44)
- 5 Horn





Handlebar fitting, right

- 1 – with heated handlebar grips^{OE}
Grip heating control (➡ 45)
- 2 Starter button (➡ 56)
- 3 Emergency off switch (kill switch) (➡ 45)

2

17

General views

Instrument panel

- 1 Warning and telltale lights (➡ 24)
- 2 Speedometer
- 3 Set the clock (➡ 39).
– with on-board computer^{OE}
Operation of the stopwatch (➡ 41)
- 4 Multifunction display (➡ 22)
- 5 Select the readings (➡ 40).
Resetting tripmeter (➡ 41).

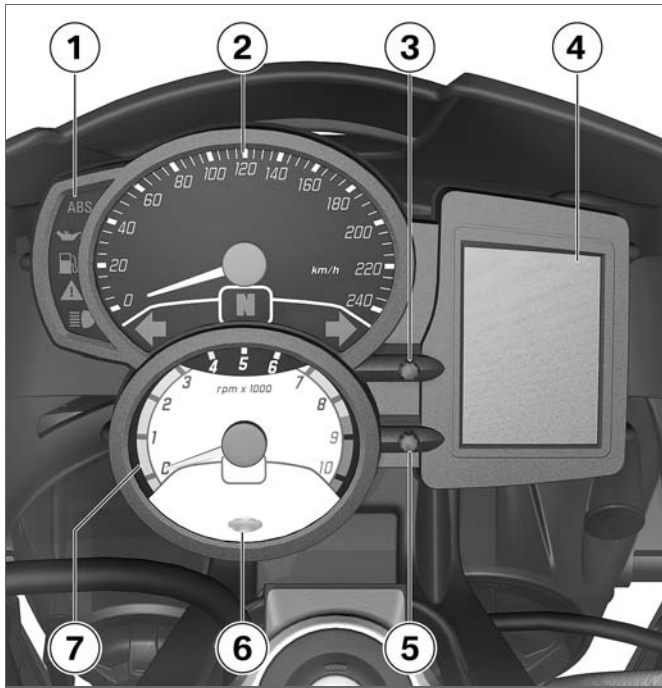

6 Ambient-light brightness sensor (for adapting the brightness of the instrument lighting)

– with anti-theft alarm^{OE}

Anti-theft alarm telltale light (see the instructions for use for the anti-theft alarm)

– with on-board computer^{OE}

Redline warning (➡ 59)

7 Rev. counter

 The instrument-cluster lighting has automatic day and night switchover.◀

General views

20

2

Status indicators

Multifunction display	22
Meaning of symbols	23
Fuel capacity	23
Warning and telltale lights.....	24
Service-due indicator	25
Kilometres travelled after fuel down to reserve.....	25
Ambient temperature	26
Tyre pressures.....	26
Warnings	27

Multifunction display

- 1 Trip meter (⇒ 40)
- 2 Warning for engine electronics (⇒ 31)
- 3 – with on-board computer^{OE}
Stopwatch (⇒ 41)
- 4 Time (⇒ 39)
- 5 – with tyre pressure monitoring (RDC)^{OE}
Tyre pressures (⇒ 26)
- 6 Warning for coolant temperature (⇒ 30)
- 7 Service due (⇒ 25)
- 8 Values area (⇒ 40)
- 9 – with on-board computer^{OE}
Symbols explaining the readings shown in the values area (⇒ 23)
- 10 – with on-board computer (optional extra)
The horizontal bars indicate the level of the coolant temperature.

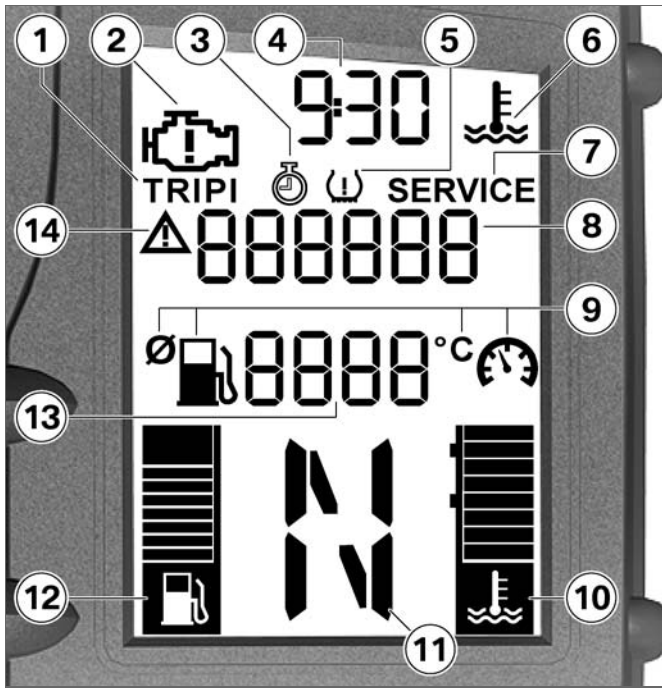



- 11** – with on-board computer (optional extra)
Gear indicator; "N" indicates neutral
- 12** – with on-board computer^{OE}
Fuel capacity (→ 23)
- 13** – with on-board computer (optional extra)
Values area (→ 40)
- 14** a warning is shown in the values area (→ 27)

Meaning of symbols

– with on-board computer^{OE}

 distance travelled after fuel down to reserve in km (→ 25)

 Average consumption in l/100 km

 Average speed in km/h

 Current consumption in l/100 km

 Ambient temperature in °C (→ 26)◁

Fuel capacity

– with on-board computer^{OE}

 The horizontal bars above the fuel-pump symbol indicate the remaining quantity of fuel. The top bar is larger than

the others and the quantity of fuel it represents is significantly larger.

Once you have refuelled, the gauge briefly shows the original level, before the reading is updated.

Warning and telltale lights

- 1 Oil-pressure warning light (➔ 31)
- 2 – with BMW Motorrad ABS^{OE}
ABS warning light (➔ 33)
- 3 Warning light for fuel down to reserve (➔ 30)
- 4 General warning light, in combination with warnings in the display (➔ 27)
- 5 High-beam headlight telltale light
- 6 Telltale light for right turn indicators
- 7 Telltale light for neutral
- 8 Telltale light for left turn indicators

 The ABS symbol might differ, depending on the specifics of national regulations. ◀



Service-due indicator



If the next service is due in less than one month, the date for the next service **1** is shown briefly after the Pre-Ride Check completes. The month is shown as a two-digit number and the year as a four-digit number, with a colon as separator, so in this example the next service is due in March 2011.



If the motorcycle covers long distances in the course of the year, under certain circumstances it might be necessary to have it serviced at a date in advance of the forecast due date. If the countdown distance to the odometer reading at which a service will be due is less than 1000 km, the distance is counted down in steps of 100 km **2** and is shown briefly after the Pre-Ride Check completes.

If service is overdue, the due date or the odometer reading at which service was due is accom-

panied by the 'General' warning light showing yellow. The word "Service" remains permanently visible.

▶ If the service-due indicator appears more than a month before the service date, the date saved in the instrument cluster must be adjusted. This situation can occur if the battery was disconnected for a prolonged period of time.

If you want to have the date set consult a specialist workshop, preferably an authorised BMW Motorrad dealer.◀

Kilometres travelled after fuel down to reserve

– with on-board computer^{OE}



Once the fuel has dropped to the reserve level, the reading shows the kilometres

travelled since then. This counter is reset as soon as refuelling brings the total quantity of fuel on board back above the reserve level.

Ambient temperature

– with on-board computer^{OE}

 When the motorcycle is at a standstill the heat of the engine can falsify the ambient-temperature reading. If the effect of the engine's heat becomes excessive, -- temporarily appears on the display.

If ambient temperature drops below 3 °C the temperature display flashes to draw your attention to the risk of black ice forming. The display automatically switches from any other mode to the temperature reading when the temperature drops below this threshold for the first time.<

Tyre pressures

– with tyre pressure monitoring (RDC)^{OE}

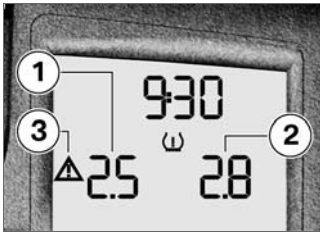

The tyre-pressure readings are based on a reference tyre temperature of 20 °C. The front tyre pressure is on the left **1**; the reading on the right **2** is the rear tyre pressure. "-- --" appears directly after the ignition is switched on, because the sensors do not transmit tyre pressures until the first time the motorcycle accelerates to more than 30 km/h.<



If warning triangle **3** also shows, the reading is a warning. The critical pressure flashes.

If the critical value is close to the limit of the permissible tolerance range, the reading is accompanied by the 'General' warning light showing yellow. If the tyre pressure registered by the sensor is outside the permissible tolerance range, the 'General' warning light flashes red.

The detailed description of BMW Motorrad RDC starts on page (➔ 68) .

Warnings

Warnings in multifunction display

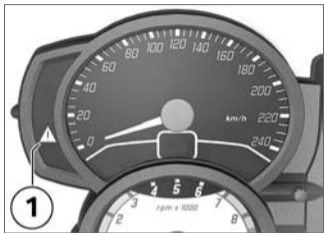

Warnings that do not have warning lights of their own are indicated by 'General' warning light **1** showing in combination with a text warning or a warning symbol in the multifunction display. The 'General' warning light shows red or yellow, depending on the urgency of the warning.

























A reading in values area **2** that constitutes a warning is accompanied by warning triangle **3**. These warnings can alternate with the odometer readings (→ 40).

The status of the 'General' warning light matches the most urgent warning.

The possible warnings are listed on the next page.

Warnings, overview**Warning light****Status indicators****Meaning**

	Lights up yellow		+ "EWS" appears on the display	Electronic immobiliser active (→ 30)
	Lights up			Fuel down to reserve (→ 30)
	Lights up red		Flashes	Coolant temperature too high (→ 30)
	Lights up yellow		Appears on the display	Engine in emergency-operation mode (→ 31)
	Flashes			Insufficient engine oil pressure (→ 31)
	Lights up yellow		+ "LAMP" appears on the display	Bulb defective (→ 31)
			"x . x °C" flashes	Ice warning (→ 32)
	Lights up yellow		+ "dWA" appears on the display	Anti-theft alarm battery flat (→ 32)

Warning light	Status indicators	Meaning
 Flashes		ABS self-diagnosis not completed (➡ 33)
 Lights up		ABS fault (➡ 33)
 Lights up yellow	 + "x . x" flashes	Tyre pressure close to limit of permitted tolerance (➡ 33)
 Flashes red	 + "x . x" flashes	Tyre pressure outside permitted tolerance (➡ 33)
	 + "--" or "-- --" appears on the display.	Signal transmission disrupted (➡ 34)
 Lights up yellow	 + "--" or "-- --" appears on the display.	Sensor defective or system error (➡ 35)
 Lights up yellow	 + "RdC" appears on the display.	Battery of tyre-pressure sensor weak (➡ 35)

Electronic immobiliser active



General warning light shows yellow.



+ "EWS" appears on the display.

Possible cause:

The key being used is not authorised for starting, or communication between key and engine electronics is disrupted.

- Remove all other vehicle keys from the same ring as the ignition key.
- Use the reserve key.
- Have the defective key replaced, preferably by an authorised BMW Motorrad dealer.

Fuel down to reserve



Warning light for fuel down to reserve shows.



Lack of fuel can result in the engine misfiring and cutting out unexpectedly. Misfiring can damage the catalytic converter; a hazardous situation can result if the engine cuts out unexpectedly.

Do not run the fuel tank dry.◀

Possible cause:

The fuel tank contains no more than the reserve quantity of fuel.

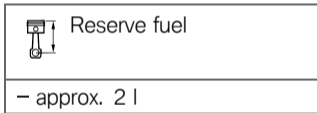

- Refuelling (➡ 62).

Coolant temperature too high



General warning light shows red.



The temperature symbol flashes.



Continuing to ride when the engine is overheated could result in engine damage.

Compliance with the information set out below is essential.◀

Possible cause:

If the coolant level is too low.

- Check the coolant level (➡ 87).

If the coolant level is too low:

- Topping up coolant (➡ 87).

Possible cause:

The coolant temperature is too high.

- If possible, ride in the part-load range to cool down the engine.
- In traffic jams, switch off the engine, but leave the ignition switched on so that the radiator fan continues to operate.
- If the coolant temperature is frequently too high, have the fault rectified as soon as possible by a specialist workshop,

preferably an authorised BMW Motorrad dealer.

Engine in emergency-operation mode



General warning light shows yellow.



Engine symbol appears on the display.



The engine is running in emergency operating mode. Full engine power or full engine rpm might not be available and this can cause hazardous situations, particularly if you attempt to overtake other road users. Engine power level might be lower than normal: adapt your style of riding accordingly.◀

Possible cause:

The engine control unit has diagnosed a fault. In exceptional cases, the engine stops and refuses to start. Otherwise, the en-

gine runs in emergency operating mode.

- You can continue to ride, but bear in mind that the usual engine power might not be available.
- Have the fault rectified as quickly as possible by a specialist workshop, preferably an authorised BMW Motorrad dealer.

Insufficient engine oil pressure



Warning light for engine-oil pressure flashes.

The oil pressure in the lube-oil system is too low. Stop immediately and switch off the engine.



The insufficient oil pressure warning does not fulfil the function of an oil gauge. The only way of checking whether the oil level is correct is to check with the oil dipstick.◀

Possible cause:

The engine-oil level is too low.

- Checking engine oil level (→ 81).

If the oil level is too low:

- Top up the engine oil (→ 82).

Possible cause:

The engine-oil pressure is insufficient.



Riding when engine-oil pressure is low can result in engine damage.

Do not continue your journey.◀

- Have the fault rectified as quickly as possible by a specialist workshop, preferably an authorised BMW Motorrad dealer.

Bulb defective



General warning light shows yellow.



+ "LAMP" appears on the display.



A defective bulb places your safety at risk because it is easier for other users to oversee the motorcycle. Replace defective bulbs as soon as possible; always carry a complete set of spare bulbs if possible. ◀

Possible cause:

Bulb defective.

- Visually inspect to ascertain which bulb is defective.
- Replacing low-beam and high-beam headlight bulb (➡ 99).
- Replacing parking-light bulb (➡ 100).
- Replacing the brake light and rear light bulbs (➡ 102).
- Replacing turn indicator bulbs, front and rear (➡ 103).

Ice warning

– with on-board computer^{OE}

"x . x °C" (ambient temperature) flashes.

Possible cause:

The air temperature measured at the motorcycle is lower than 3 °C.



The ice warning does not mean that there is no risk of black ice forming at measured temperatures above 3 °C.

Always take extra care when temperatures are low; remember that the danger of black ice forming is particularly high on bridges and where the road is in shade. ◀

- Ride carefully and think well ahead.

Anti-theft alarm battery flat

– with anti-theft alarm^{OE}



General warning light shows yellow.



+ "dWA" appears on the display.



This error message appears only briefly after the pre-ride check completes. ◀

Possible cause:

The integral battery in the anti-theft alarm has lost its entire original capacity. There is no assurance that the anti-theft alarm will be operational if the motorcycle's battery is disconnected.

- Seek the advice of a specialist workshop, preferably an authorised BMW Motorrad dealer.

ABS self-diagnosis not completed

– with BMW Motorrad ABS^{OE}



ABS warning light flashes.

Possible cause:

The ABS function is not available, because self-diagnosis did not complete. The motorcycle has to move forward a few metres for the wheel sensors to be tested.

- Pull away slowly. Bear in mind that the ABS function is not available until self-diagnosis has completed.

ABS fault

– with BMW Motorrad ABS^{OE}



ABS warning light shows.

Possible cause:

The ABS control unit has detected a fault. The ABS function is not available.

- You can continue to ride. Bear in mind that the ABS function is not available. Bear in mind the more detailed information on situations that can lead to an ABS fault (➔ 67).
- Have the fault rectified as quickly as possible by a specialist workshop, preferably an authorised BMW Motorrad dealer.

Tyre pressure close to limit of permitted tolerance

– with tyre pressure monitoring (RDC)^{OE}



General warning light shows yellow.



+ "x . x" (critical pressure) flashes.

Possible cause:

Measured tyre pressure is close to the limit of permitted tolerance.

- Correct the tyre pressure as stated on the inside cover of the Rider's Manual.



Before you adjust tyre pressure, read the information on temperature compensation and adjusting pressure in the section entitled "Engineering details".◀

Tyre pressure outside permitted tolerance

– with tyre pressure monitoring (RDC)^{OE}



General warning light flashes red.



+ "x . x" (critical pressure) flashes.

Possible cause:

Measured tyre pressure is outside permitted tolerance.

- Check the tyre for damage and to ascertain whether the motorcycle can be ridden with the tyre in its present condition.

If the motorcycle can be ridden with the tyre in its present condition:



Incorrect tyre pressures impair the motorcycle's handling characteristics.

If tyre pressure is incorrect it is essential to adapt your style of riding accordingly. ◀

- Correct the tyre pressure at the earliest possible opportunity.
- Have the tyre checked for damage by a specialist workshop, preferably an

authorised BMW Motorrad dealer.

If you are unsure whether the motorcycle can be ridden with the tyre in its present condition:

- Do not continue your journey.
- Notify the breakdown service.
- Have the tyre checked for damage by a specialist workshop, preferably an authorised BMW Motorrad dealer.

Signal transmission disrupted

– with tyre pressure monitoring (RDC)^{OE}



+ "---" or "--- ---" appears on the display.

Possible cause:

The motorcycle has not yet accelerated past the threshold of approximately 30 km/h. The RDC sensors do not start transmitting signals until the motor-

cycle reaches a speed above this threshold (➡ 68).

- Increase speed above this threshold and observe the RDC readings. Assume that a permanent fault has not occurred unless the 'General' warning light comes on to accompany the symptoms. Under these circumstances:
- Have the fault rectified by a specialist workshop, preferably an authorised BMW Motorrad dealer.

Possible cause:

Wireless communication with the RDC sensors has been disrupted. Possible causes include radio-communication systems operating in the vicinity and interfering with the link between the RDC control unit and the sensors.

- Move to another location and observe the RDC readings. Assume that a permanent fault

has not occurred unless the 'General' warning light comes on to accompany the symptoms. Under these circumstances:

- Have the fault rectified by a specialist workshop, preferably an authorised BMW Motorrad dealer.

Sensor defective or system error

– with tyre pressure monitoring (RDC)^{OE}



General warning light shows yellow.



+ "--" or "-- --" appears on the display.

Possible cause:

Motorcycle is fitted with wheels not equipped with RDC sensors.

- Fit wheels and tyres equipped with RDC sensors.

Possible cause:

One or two RDC sensors have failed.

- Have the fault rectified by a specialist workshop, preferably an authorised BMW Motorrad dealer.

Possible cause:

A system error has occurred.

- Have the fault rectified by a specialist workshop, preferably an authorised BMW Motorrad dealer.

Battery of tyre-pressure sensor weak

– with tyre pressure monitoring (RDC)^{OE}



General warning light shows yellow.



+ "RdC" appears on the display.



This error message appears only briefly after the pre-ride check completes. ◀

Possible cause:

The integral battery in the tyre-pressure sensor has lost a significant proportion of its original capacity. There is no assurance of how long the tyre pressure control system can remain operational.

- Seek the advice of a specialist workshop, preferably an authorised BMW Motorrad dealer.

Status indicators

36

3

Operation

Ignition switch and steering lock	38	Damping	49
Electronic immobiliser EWS.....	39	Tyres	49
Clock	39	Headlight	50
Reading.....	40	Seat	51
Stopwatch	41		
Lights	43		
Turn indicators.....	44		
Hazard warning flashers.....	44		
Emergency off switch (kill switch)	45		
Grip heating.....	45		
Clutch	46		
Brakes	46		
Mirrors	47		
Spring preload	48		

Ignition switch and steering lock

Keys

You receive two master keys and one spare key. Please consult the information on the electronic immobiliser (EWS) if a key is lost or mislaid (➔ 39).

Ignition switch and steering lock, tank filler cap lock and seat lock are all operated with the same key.

- with case^{OA}
- with topcase^{OA}

If you wish you can arrange to have the cases and the topcase fitted with locks that can be opened with this key as well. Consult a specialist workshop, preferably an authorised BMW Motorrad dealer.◀

Switching on ignition

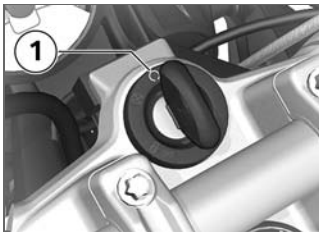

- Turn the key to position **1**.
 - » Parking lights and all function circuits switched on.
 - » Engine can be started.
 - » Pre-ride check is performed. (➔ 57)
- with BMW Motorrad ABS^{OE}
 - » ABS self-diagnosis is performed. (➔ 58)

Switching off ignition



- Turn the key to position **2**.
 - » Lights switched off.
 - » Handlebars not locked.
 - » Key can be removed.
 - » Electrically powered accessories remain operational for a limited period of time.
 - » The battery can be recharged via the on-board socket.

Locking handlebars

- Turn the handlebars all the way to left

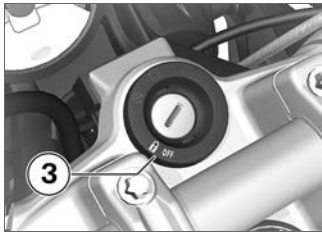

- Turn the key to position **3**, while moving the handlebars slightly.
- » Ignition, lights and all function circuits switched off.
- » Handlebars locked.
- » Key can be removed.

Electronic immobiliser EWS

The motorcycle's electronics exchange certain continuously changing signals with the electronics in the key; these signals are specific to your motorcycle and they are transmitted via the

ring aerial in the ignition lock. The ignition is not enabled for starting until the engine control unit has recognised the key as "authorised" for your motorcycle.

▶ A spare key attached to the same ring as the ignition key used to start the engine could "irritate" the electronics, in which case the enabling signal for starting is not issued. The EWS warning appears in the multifunction display.

Always keep the spare key separately from the ignition key.◀

If you mislay a key you can have the key in question barred by your authorised BMW Motorrad dealer. In order to have a key barred you must bring along all the other keys belonging to the motorcycle.

The engine cannot be started by a barred key, but a key that has

been barred can subsequently be reactivated.

You can obtain replacement/extra keys only through an authorised BMW Motorrad dealer. The keys are part of an integrated security system, so the dealer is under an obligation to check the legitimacy of all applications for replacement/extra keys.

Clock

Setting clock

⚠ Attempting to set the clock while riding the motorcycle can lead to accidents.

Set the clock only when the motorcycle is stationary.◀

- Switch on the ignition.

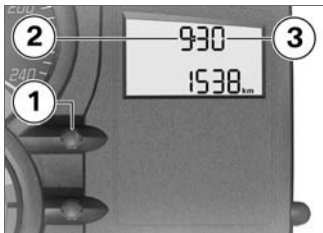

- Press and hold down button **1** until the hours number **2** flashes.
- Repeatedly press the button until the hours number is correct.
- Press and hold down the button until the minutes number **3** flashes.
- Repeatedly press the button until the minutes number is correct.
- Hold down the button until the minutes number stops flashing.
» This completes the process.

Reading

Select the readings

- Switch on the ignition.



- Press button **2** to select the reading in values area **3**. The following values can be displayed:

- Total kilometres (shown)
- Tripmeter 1 (Trip I)
- Tripmeter 2 (Trip II)

- with tyre pressure monitoring (RDC)^{OE}



Tyre pressures

- Warnings, if applicable

- with on-board computer^{OE}

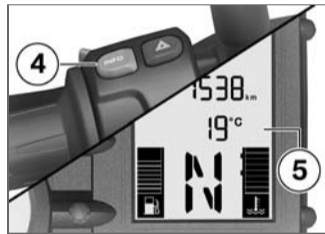

- Press button **4** to select the reading in values area **5**. The following values can be displayed:

- Ambient temperature (°C)



Average speed in km/h



Average consumption in l/100 km



Current consumption in l/100 km



distance travelled after fuel down to reserve in km

Resetting tripmeter

- Switch on the ignition.
- Select the desired tripmeter.



- Press and hold down button **2** until the tripmeter reading is reset.

Resetting average values

– with on-board computer^{OE}

- Switch on the ignition.
- Select average consumption or average speed.



- Press and hold down button **1** until the value shown is reset.

Stopwatch

– with on-board computer^{OE}

Stopwatch

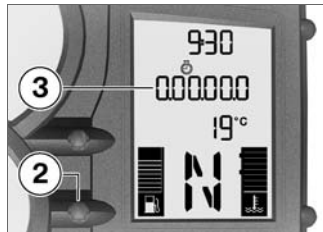

You can switch from the odometer reading to a stopwatch **3**. The readout is in hours, minutes, seconds and tenths of a second, with dots as separators.

By swapping the functions of button **2** and the INFO button on the handlebar fitting you can make the stopwatch easier to use (as a lap timer) as you ride. If you swap the functions in this way the stopwatch and the odometer are operated by means of the INFO button and you must

use button **2** to operate the on-board computer.

The stopwatch continues to time in the background if you switch back temporarily to the odometer reading. Similarly, the stopwatch continues timing if you temporarily switch off the ignition.

Operating stopwatch

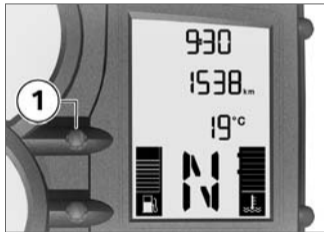

- If necessary, use button **1** to switch from the odometer to the stopwatch.

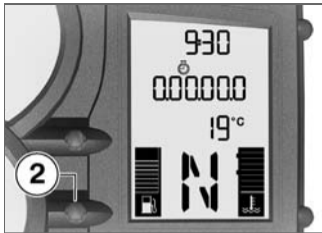

- When the stopwatch is stopped, press button **2** to start timing with the stopwatch.
- When the stopwatch is running, press button **2** to stop timing with the stopwatch.
- Press and hold down button **2** to reset the stopwatch.

Changing button functions

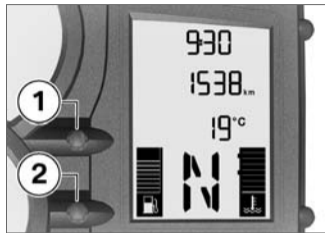

- Press button **1** and button **2** at the same time and hold them down until the reading changes.
 - » FLASH (redline warning) appears, along with ON or OFF.
- Press button **2**.
 - » LAP (Lap-Timer) and ON or OFF appear.
- Repeatedly press button **1** until the reading shows the mode you want.

- » ON: Stopwatch operated by means of the INFO button on the handlebar fitting.
- » OFF: Stopwatch operated by means of button **2** in the instrument panel.
- To save the setting, press button **1** and button **2** at the same time and hold them down until the reading changes.

Lights

Side light

The side lights switch on automatically when the ignition is switched on.

- ▶ The side lights place a strain on the battery. Do not switch the ignition on for longer than absolutely necessary.◀

Low-beam headlight

The low-beam headlight switches on automatically when you start the engine.

- ▶ When the engine is not running you can switch on the lights by switching on the ignition and either switching on the high-beam headlight or operating the headlight flasher.◀

High-beam headlight and headlight flasher



- Push switch **1** forward to switch on the high-beam headlight.

- Pull switch **1** back to operate the headlight flasher.

Parking light

- Switch off the ignition.



- Immediately after switching off the ignition, push button **1** to the left and hold it in this position until the parking lights come on.
- Switch the ignition on and off again to switch off the parking lights.

Turn indicators

Operating flashing turn indicators

- Switch on the ignition.

▶ The turn indicators are cancelled automatically after you have ridden for approximately 10 seconds, or covered a distance of about 200 m.◀



- Push button **1** to the left to switch on the left flashing turn indicators.
- Push button **1** to the right to switch on the right flashing turn indicators.

- Centre button **1** to cancel the flashing turn indicators.

Hazard warning flashers

Operating hazard warning flashers

- Switch on the ignition.

▶ The hazard warning flashers place a strain on the battery. Do not use the hazard warning flashers for longer than absolutely necessary.◀

▶ If you press a turn-indicator button with the ignition switched on, the turn-indicator function is activated instead of the hazard warning flashers, and remains active until you release the button. The hazard warning flashers recommence flashing as soon as the button is released.◀



- Press button **1** to switch on the hazard warning flashers.
- » Ignition can be switched off.
- Press button **1** again to switch off the hazard warning flashers.

Emergency off switch (kill switch)



1 Emergency off switch (kill switch)

 Operating the kill switch when riding can cause the rear wheel to lock and thus cause a fall.

Do not operate the kill switch when riding. ◀

The emergency off switch is a kill switch for switching off the engine quickly and easily.



a Engine switched off
b Normal operating position (run)

Grip heating

– with heated handlebar grips^{OE}

Operating grip heating

- Start the engine.

 Grip heating can be activated only when the engine is running. ◀

 The increase in power consumption caused by the grip heating can drain the battery if you are riding at low en-

gine speeds. If the charge level is low, grip heating is switched off to ensure the battery's starting capability. ◀



- Repeatedly press button **1** until the desired heating stage appears on the display.



The handlebar grips have two-stage heating. Stage two **2** is for heating the grips quickly: it is advisable to switch back to stage one as soon as the grips are warm.



50 % heating power



100 % heating power

» The selected heating stage will be saved if you allow a certain length of time to pass without making further changes.

Clutch

Adjusting clutch lever

 Attempting to adjust the clutch lever while riding the motorcycle can lead to accidents. Do not attempt to adjust the clutch lever unless the motorcycle is at a standstill.◀

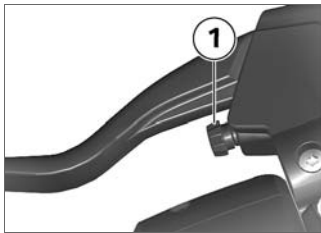

- Turn adjusting screw **1** clockwise to increase the span between the clutch lever and the handlebar grip.
- Turn adjusting screw **1** counter-clockwise to reduce

the span between the clutch lever and the handlebar grip.

 The adjusting screw is easier to turn if you push the clutch lever forward.◀

Brakes

Adjust the handbrake lever

 Changing the position of the brake-fluid reservoir can allow air to penetrate the brake system.

Do not twist the handlebar fitting or the handlebars.◀

 Attempting to adjust the handbrake lever while riding the motorcycle can lead to accidents.

Do not attempt to adjust the handbrake lever unless the motorcycle is at a standstill.◀

Mirrors

Adjusting mirrors

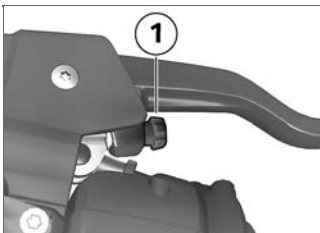

- Turn adjusting screw **1** clockwise to increase the span between the brake lever and the handlebar grip.
- Turn adjusting screw **1** counter-clockwise to reduce the span between the brake lever and the handlebar grip.

▶ The adjusting screw is easier to turn if you push the handbrake lever forward. ◀



- Turn the mirror to the correct position.

Adjusting mirror arm

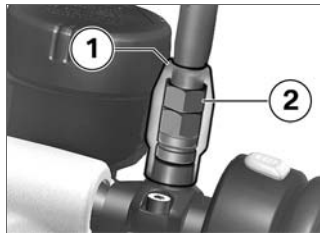

- Push protective cap **1** up over the threaded fastener on the mirror arm.
- Slacken nut **2**.
- Turn the mirror arm to the appropriate position.
- Tighten the nut to the specified tightening torque, while holding the mirror arm to ensure that it does not move out of position.



Locknut (mirror) to clamp adapter

– 20 Nm

- Push the protective cap over the threaded fastener.

Spring preload

Setting

It is essential to set spring preload of the rear suspension to suit the load carried by the motorcycle. Increase spring preload when the motorcycle is heavily loaded and reduce spring preload accordingly when the motorcycle is lightly loaded.

Adjusting spring preload for rear wheel

- Remove the seat (➡ 51).

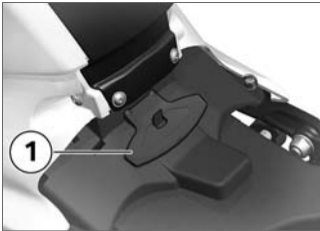

- Remove on-board toolkit **1**.

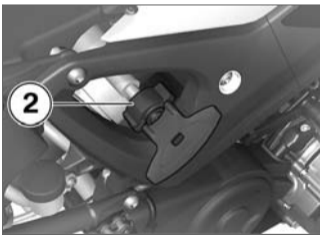

! Your motorcycle's handling will suffer if you do not match the spring-preload and damping-characteristic settings.

Adjust the damping characteristic to suit spring preload. ◀

- If you want to increase spring preload, use the tool from the on-board toolkit to turn knob **2** clockwise.
- If you want to reduce spring preload, use the tool from the on-board toolkit to turn knob **2** counter-clockwise.



Basic setting of spring preload, rear

- Turn adjusting screw as far as it will go counter-clockwise, then back it off 12 clicks. (Full load of fuel, with rider 85 kg)

- Stow the on-board toolkit in its correct position.
- Install the seat (➡ 51).

Damping

Setting

Damping must be adapted to suit the surface on which the motorcycle is ridden and to suit spring preload.

- An uneven surface requires softer damping than a smooth surface.
- An increase in spring preload requires firmer damping, a reduction in spring preload requires softer damping.

Adjusting damping for rear wheel

- Make sure the ground is level and firm and place the motorcycle on its stand.



- If you want to increase damping, turn adjusting screw **1** clockwise.
- If you want to reduce damping, turn adjusting screw **1** counter-clockwise.



Basic setting of rear-suspension damping characteristic

- Turn adjusting screw as far as it will go clockwise, then back it off 3/4 turns. (full load of fuel, with rider 85 kg)

Tyres

Checking tyre pressure



Incorrect tyre pressures impair the motorcycle's handling characteristics and increase the rate of tyre wear.

Always check that the tyre pressures are correct. ◀





At high road speeds, tyre valves installed perpendicular to the wheel rim have a tendency to open as a result of centrifugal force.

In order to avoid sudden deflation, fit valves installed perpendicular to the rim with valve caps complete with rubber seals and make sure the valve caps are screwed firmly on to the valves. ◀

- Make sure the ground is level and firm and place the motorcycle on its stand.

- Check tyre pressures against the data below.

 Tyre pressure, front
– 2.5 bar (Tyre cold)

 Tyre pressure, rear
– 2.9 bar (Tyre cold)

If tyre pressure is too low:

- Correct tyre pressure.

Headlight

Adjusting headlight for driving on left/driving on right

If the motorcycle is ridden in a country where the opposite rule of the road applies, its asymmetric low-beam headlight will tend to dazzle oncoming traffic.

Have the headlight set accordingly by a specialist workshop,

preferably an authorised BMW Motorrad dealer.

Headlight beam throw and spring preload

Headlight beam throw is generally kept constant when spring preload is adjusted to suit load. Spring preload adjustment might not suffice only if the motorcycle is very heavily loaded. Under these circumstances, headlight beam throw has to be adjusted to suit the weight carried by the motorcycle.

 Consult a specialist workshop, preferably an authorised BMW Motorrad dealer, if you are unsure whether the headlight beam-throw setting is correct. ◀

Adjusting headlight beam throw



- Slacken screws **1** on left and right.
- Adjust beam throw by tilting the headlight slightly about its horizontal axis.
- Tighten screws **1** on left and right.

Beam-throw basic setting

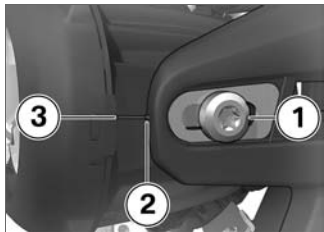

- Slacken screws **1** on left and right.
- Tilt the headlight slightly about its horizontal axis until arrowhead **2** is pointing toward marker **3**.
- Tighten screws **1** on left and right.

Seat

Removing seat

- Make sure the ground is level and firm and place the motorcycle on its stand.

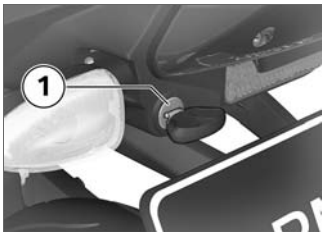

- Turn the key to the left in seat lock **1** and hold it in this position while pressing down the rear part of the seat.

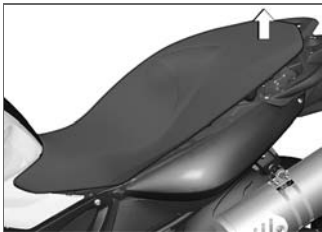

- Lift the seat at the rear and release the key.

- Remove the seat and place it, upholstered side down, on a clean surface.

Installing seat

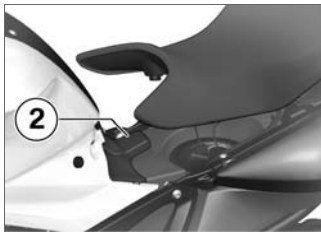

- Engage the seat in holder **2**.
- Firmly press down on the seat at the rear.
 - » The seat engages with an audible click.

Operation

4

52

Riding

Safety instructions	54
Checklist.....	56
Starting	56
Running in	58
speed.....	59
Brakes	60
Parking your motorcycle	61
Refuelling.....	62
Securing motorcycle for transportation	63

Safety instructions

Rider's equipment

Do not ride without the correct clothing. Always wear:

- Helmet
- Motorcycling jacket and trousers
- Gloves
- Boots

This applies even to short journeys, and to every season of the year. Your authorised BMW Motorrad dealer will be glad to advise you on the correct clothing for every purpose.

Correct loading

 Overloading and imbalanced loads can adversely affect the motorcycle's handling. Do not exceed the permissible gross weight and be sure to comply with the instructions on loading. ◀

- Set spring preload, damping characteristic and tyre pressures to suit total weight.
- with case^{OA}
- Ensure that the case volumes on the left and right are equal.
- Make sure that the weight is uniformly distributed between right and left.
- Pack heavy items at the bottom and toward the inboard side.
- Note the maximum permissible payload and the speed limit for riding with cases fitted, as stated on the label inside the case. ◀
- with topcase^{OA}
- Note the maximum permissible payload and the speed limit for riding with topcase fitted, as stated on the label inside the topcase. ◀

- with tank rucksack^{OA}
- Note the maximum permissible payload of the tank rucksack.

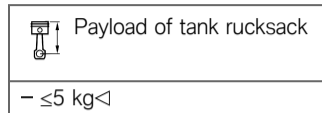

- with tankbag^{OA}
- Note the maximum permissible payload of the tankbag.

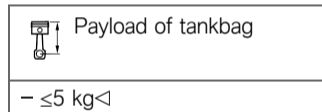

Speed

If you ride at high speed, always bear in mind that various boundary conditions can adversely affect the handling of your motorcycle:

- Settings of the spring-strut and shock-absorber system
- Imbalanced load
- Loose clothing
- Insufficient tyre pressure
- Poor tyre tread
- Etc.

Risk of poisoning

Exhaust fumes contain carbon monoxide, which is colourless and odourless but highly toxic.

 Inhaling the exhaust fumes therefore represents a health hazard and can even cause loss of consciousness with fatal consequences.

Do not inhale exhaust fumes.
Do not run the engine in an enclosed space.◀

Catalytic converter

If misfiring causes unburned fuel to enter the catalytic converter, there is a danger of overheating and damage.

For this reason, observe the following points:

- Do not run the fuel tank dry.
- Do not attempt to start or run the engine with a spark-plug cap disconnected.
- Stop the engine immediately if it misfires.
- Use only unleaded fuel.
- Comply with all specified maintenance intervals.

 Unburned fuel will destroy the catalytic converter.

Note the points listed for protection of the catalytic converter.◀

Risk of overheating

 Cooling would be inadequate if the engine were allowed to idle for a lengthy period with the motorcycle at a standstill: overheating would result. In extreme cases, the motorcycle could catch fire. Do not allow the engine to idle unnecessarily. Ride away immediately after starting the engine.◀

Tampering

 Tampering with motorcycle settings (e.g. electronic engine management unit, throttle valves, clutch) can cause damages to the components in question and lead to failure of safety-relevant functions. Damage caused in this way is not covered by the warranty.

Do not tamper with the motorcycle in any way that could result in tuned performance.◀

Checklist

Use the following checklist to check important functions, settings and wear limits before you ride off.

- Brakes
- Brake-fluid levels, front and rear
- Clutch
- Damping-characteristic setting and spring preload
- Tyre-tread depth and tyre pressures
- Cases correctly installed and luggage secured

At regular intervals:

- Engine oil level (every refuelling stop)
- Brake-pad wear (every third refuelling stop)
- Tension and lubrication of the drive chain

Starting

Side stand

You cannot start the motorcycle with the side stand extended and a gear engaged. The engine will switch itself off if you start it with the gearbox in neutral and then engage a gear before retracting the side stand.

Gearbox

You can start the engine when the gearbox is in neutral or if you pull the clutch with a gear engaged. Do not pull the clutch until after you have switched on the ignition, as otherwise the engine will refuse to start.

Starting engine



Gearbox lubrication is ensured only when the engine is running. Inadequate lubrication can result in damage to the gearbox.

Do not allow the motorcycle to roll for a lengthy period of time or push it a long distance with the engine switched off. ◀

- Switch on the ignition.
 - » Pre-ride check is performed. (☞ 57)
- with BMW Motorrad ABS^{OE}
 - » ABS self-diagnosis is performed. (☞ 58)



- Press starter button **1**.

▶ If ambient temperatures are very low, you might find it necessary to open the throttle slightly when starting the engine. At ambient temperatures below

0 °C, disengage the clutch after switching on the ignition.◀

▷ The start attempt is automatically interrupted if battery voltage is too low. Recharge the battery before you start the engine, or use jump leads and a donor battery to start.◀

- » The engine starts.
- » If the engine refuses to start, consult the troubleshooting chart in the section entitled "Technical data". (➡ 116)

▷ If ambient temperatures are very low, you might find it necessary to open the throttle slightly when starting the engine. At ambient temperatures below 32 °F (0 °C), disengage the clutch after switching on the ignition.◀

▷ The start attempt is automatically interrupted if battery voltage is too low. Recharge the battery before you start the engine, or use jump leads and a donor battery to start.◀

- » The engine starts.
- » If the engine refuses to start, consult the troubleshooting chart in the section entitled "Technical data". (➡ 116)◀

Pre-ride check

The instrument panel runs a test of the instruments and the telltale and warning lights when the ignition is switched on: this is the Pre-Ride-Check The test is abor-

ted if you start the engine before it completes.

Phase 1

The rev. counter and speedometer needles both swing to the limit values on their scales. At the same time, all the warning lights and telltale lights are switched on in succession.

Phase 2

- » The 'General' warning light changes from yellow to red.

Phase 3

The rev. counter and speedometer needles both swing back to rest. At the same time, all the warning lights and telltale lights switched on in the initial phase are switched off in reverse sequence.



- Press starter button 1.

If a needle did not move or if a warning light or telltale light did not show:



Some malfunctions cannot be indicated if one of the warning lights fails to show.

Make sure that all the warning and telltale lights come on in the pre-ride check. ◀

- Have the fault rectified as quickly as possible by a specialist workshop, preferably an authorised BMW Motorrad dealer.

ABS self-diagnosis

– with BMW Motorrad ABS^{OE}

BMW Motorrad ABS performs self-diagnosis to ensure its operability. Self-diagnosis is performed automatically when you switch on the ignition. The motorcycle has to move forward a few metres for the wheel sensors to be tested.

Phase 1

» Test of the diagnosis-compatible system components with the motorcycle at a standstill.



ABS warning light flashes.

Phase 2

» Test of the wheel sensors as the motorcycle pulls away from rest.



ABS warning light flashes.

ABS self-diagnosis completed

» The ABS warning light goes out.

If an indicator showing an ABS fault appears when ABS self-diagnosis completes:

- You can continue to ride. Bear in mind that the ABS function is not available.

- Have the fault rectified as quickly as possible by a specialist workshop, preferably an authorised BMW Motorrad dealer.

Running in

The first 1000 km

- While running in the motorcycle, vary the throttle opening and engine-speed range frequently; avoid riding at constant engine rpm for prolonged periods.
- Try to do most of your riding during this initial period on twisting, fairly hilly roads, avoiding high-speed main roads and highways if possible.
- Comply with the rpm limits for running in.



Running-in speed

– <math><5000 \text{ min}^{-1}</math>

- Do not omit the first inspection after 500 - 1200 km.

Brake pads

New brake pads have to bed down before they can achieve their optimum friction levels. You can compensate for this initial reduction in braking efficiency by exerting greater pressure on the levers.

 New brake pads can extend stopping distance by a significant margin.

Apply the brakes in good time. ◀

Tyres

New tyres have a smooth surface. This must be roughened by riding in a restrained manner at various heel angles until the tyres are run in. This running in procedure is essential if the tyres are to achieve maximum grip.

 Tyres do not have their full grip when new and there is a risk of accidents at extreme angles of heel.

Avoid extreme angles of heel. ◀

speed

– with on-board computer^{OE}

Redline warning

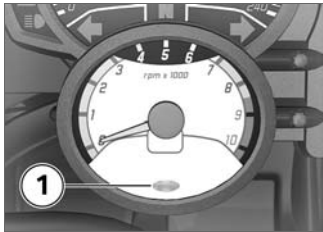

The redline warning indicates that engine revolutions have reached the rev. counter's red segment. The anti-theft alarm telltale light **1** flashes red to in-

dicate that the engine is redlining.

The signal remains active until you shift up or reduce engine speed. You can activate or deactivate the redline warning.

Activating redline warning

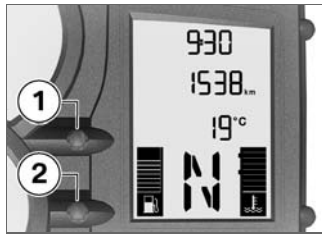

- Press button **1** and button **2** at the same time and hold them down until the reading changes.
- » FLASH (redline warning) appears, along with ON or OFF.
- Repeatedly press button **1** until the reading shows the mode you want.

- » ON: Redline warning activated.
- » OFF: Redline warning deactivated.
- To save the setting, press button **1** and button **2** at the same time and hold them down until the reading changes.

Brakes

How can stopping distance be minimised?

Each time the brakes are applied, a load distribution shift takes place with the load shifting forward from the rear to the front wheel. The sharper the motorcycle decelerates, the more load is shifted to the front wheel. The higher the wheel load, the more braking force can be transmitted without the wheel locking.

To optimise stopping distance, apply the front brakes rapidly and keep on increasing the force you

apply to the brake lever. This makes the best possible use of the dynamic increase in load at the front wheel. Remember to pull the clutch at the same time. In the "panic braking situations" that are trained so frequently braking force is applied as rapidly as possible and with the rider's full force exerted on the brake levers; under these circumstances the dynamic shift in load distribution cannot keep pace with the increase in deceleration and the tyres cannot transmit the full braking force to the surface of the road. Under these circumstances the front wheel can lock up.

– with BMW Motorrad ABS^{OE} BMW Motorrad ABS prevents the front wheel from locking up.◀

Descending mountain passes



There is a danger of the brakes fading if you use only the rear brakes when descending mountain passes. Under extreme conditions, the brakes could overheat and suffer severe damage.

Use both front and rear brakes, and make use of the engine's braking effect as well.◀

Wet and dirty brakes

Wetness and dirt on the brake discs and the brake pads diminish braking efficiency.

Delayed braking action or poor braking efficiency must be reckoned with in the following situations:

- Riding in the rain or through puddles of water.
- After the motorcycle has been washed.

- Riding on salted or gritted roads.
- After work has been carried on the brakes, due to traces of oil or grease.
- Riding on dirt-covered surfaces or off-road.



Wetness and dirt result in poor braking efficiency.

Apply the brakes lightly while riding to remove wetness and dirt, or dismount and clean the brakes.

Think ahead and brake in good time until full braking efficiency is restored.◀

Parking your motorcycle

Side stand

- Switch off the engine.



If the ground is soft or uneven, there is no guaran-

tee that the motorcycle will rest firmly on the stand.

Always check that the ground under the stand is level and firm.◀

- Extend the side stand and prop the motorcycle on the stand.



The side stand is designed to support only the weight of the motorcycle.

Do not lean or sit on the motorcycle with the side stand extended.◀

- If the camber of the roadway permits, turn the handlebars all the way to the left.
- On a gradient, the motorcycle should always face uphill; select 1st gear.

Centre stand

- with centre stand^{OA}

- Switch off the engine.



If the ground is soft or uneven, there is no guarantee that the motorcycle will rest firmly on the stand.

Always check that the ground under the stand is level and firm.◀



Excessive movements could cause the centre stand to retract, and the motorcycle would topple in consequence.

Do not lean or sit on the motorcycle with the centre stand extended.◀

- Extend the centre stand and lift the motorcycle onto the stand.

Refuelling

! Fuel is highly flammable. A naked flame close to the fuel tank can cause a fire or explosion.

Do not smoke. Never bring a naked flame near the fuel tank. ◀

! Fuel expands when hot. Fuel escaping from an overfilled tank could make its way onto the road surface. This could cause a fall.

Do not overfill the fuel tank. ◀

! Fuel attacks plastics, which become dull or unsightly. Wipe off plastic parts immediately if they come into contact with fuel. ◀

! Leaded fuel will destroy the catalytic converter. Use only unleaded fuel. ◀

- Make sure the ground is level and firm and place the motorcycle on its side stand.

▷ The volume of the tank can be utilised to the full only when the motorcycle is propped on its side stand. ◀

- Open the protective cap.

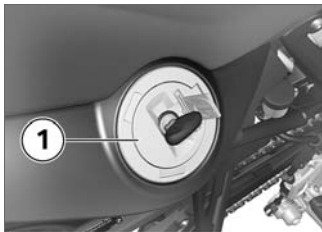

- Use the ignition key to unlock cap **1** of the fuel tank and pop the cap open.



- Refuel with fuel of the grade stated below; do not fill the tank past the bottom edge of the filler neck.

▷ When refuelling after running on reserve, make sure that you top up the tank to a level above reserve, as otherwise the sensor will not be able to register the new level. If the sensor cannot register the new level neither the fuel-level reading nor the range readout can be updated. ◀



Recommended fuel grade

- Super unleaded
- 95 ROZ/RON
- 89 AKI



Usable fuel capacity

- approx. 16 l



Reserve fuel

- approx. 2 l

- Press the fuel tank cap down firmly to close.
- Remove the key and close the protective cap.

Securing motorcycle for transportation

- Make sure that all components that might come into contact with straps used to secure the

motorcycle are adequately protected against scratching. Use adhesive tape or soft cloths, for example, for this purpose.



 The motorcycle can topple and fall on its side. Make sure that the motorcycle cannot topple sideways.◀

- Push the motorcycle onto the transportation flat and hold it in position: do not place it on the side stand or centre stand.



Risk of damaging components.

Take care not to trap components such as brake lines or wires.◀

- At the front, secure the straps to the bottom fork bridge on both sides and tighten the straps.



- At the rear, secure the straps to the rear footrests on both sides and tighten the straps.
- Tighten all the straps uniformly; the motorcycle's suspension should be compressed as tightly as possible front and rear.

Engineering details

Brake system with BMW Motorrad ABS	66
Tyre pressure monitoring RDC	68

Brake system with BMW Motorrad ABS

– with BMW Motorrad ABS^{OE}

How does ABS work?

The amount of braking force that can be transferred to the road depends on factors that include the coefficient of friction of the road surface. Loose stones, ice and snow or a wet road all have much lower coefficients of friction than a clean, dry asphalt surface. The lower the coefficient of friction, the longer the braking distance.

If the rider increases braking pressure to the extent that braking force exceeds the maximum transferrable limit, the wheels start to lock and the motorcycle loses its directional stability; a fall is imminent. Before this situation can occur, ABS intervenes and adapts braking pressure to the maximum transferrable braking

force, so the wheels continue to turn and directional stability is maintained irrespective of the condition of the road surface.

What are the effects of surface irregularities?

Humps and surface irregularities can cause the wheels to lose contact temporarily with the road surface; if this happens the braking force that can be transmitted to the road can drop to zero. If the brakes are applied under these circumstances the ABS has to reduce braking force to ensure that directional stability is maintained when the wheels regain contact with the road surface. At this instant the BMW Motorrad ABS must assume an extremely low coefficient of friction, so that the wheels will continue to rotate under all imaginable circumstances, because this is the precondition for ensuring

directional stability. As soon as it registers the actual circumstances, the system reacts instantly and adjusts braking force accordingly to achieve optimum braking.

Rear wheel lift

Under very severe and sudden deceleration, however, under certain circumstances it is possible that the BMW Motorrad ABS will be unable to prevent the rear wheel from lifting clear of the ground. If this happens the outcome can be a highside situation in which the motorcycle can flip over.



Severe braking can cause the rear wheel to lift off the ground.

When you brake, bear in mind that ABS control cannot be relied on in all circumstances to prevent the rear wheel from lifting clear of the ground. ◀

What is the design baseline for BMW Motorrad ABS?

Within the limits imposed by physics, BMW Motorrad ABS ensures directional stability on any surface. The system is not optimised for special requirements that apply under extreme competitive situations off-road or on the track.

Special situations

The speeds of the front and rear wheels are compared as one means of detecting a wheel's incipient tendency to lock. If the system registers implausible values for a lengthy period the ABS function is deactivated for safety reasons and an ABS fault message is issued. Self-diagnosis has to complete before fault messages can be issued.

In addition to problems with the BMW Motorrad ABS, exceptional

riding conditions can lead to a fault message being issued.

Exceptional riding conditions:

- Riding for a lengthy period with the front wheel lifted off the ground (wheelie).
- Rear wheel rotating with the motorcycle held stationary by applying the front brake (burn-out).
- Heating up with the motorcycle on the centre stand or an auxiliary stand, engine idling or with a gear engaged.
- Rear wheel locked for a lengthy period, for example while descending off-road.

If a fault message is issued on account of exceptional riding conditions as outlined above, you can reactivate the ABS function by switching the ignition off and on again.

What significance devolves on regular maintenance?



Invariably, a technical system cannot perform beyond the abilities dictated by its level of maintenance.

In order to ensure that the BMW Motorrad ABS is always maintained in optimum condition, it is essential for you to comply strictly with the specified inspection intervals. ◀

Reserves for safety

The potentially shorter braking distances which BMW Motorrad ABS permits must not be used as an excuse for careless riding. ABS is primarily a means of ensuring a safety margin in genuine emergencies.

Take care when cornering. When you apply the brakes on a corner, the motorcycle's weight and

momentum take over and even BMW Motorrad ABS is unable to counteract their effects.

Tyre pressure monitoring RDC

– with tyre pressure monitoring (RDC)^{OE}

Function

A sensor integrated into each tyre measures the air temperature and the air pressure inside the tyre and transmits this information to the control unit.

Each sensor has a centrifugal-force tripswitch that does not enable transmission of the measured values until the motorcycle has accelerated to about 30 km/h. The display shows – for each tyre until the tyre-pressure signal is received for the first time. The sensors continue to transmit the measured-value sig-

nals for approximately 15 minutes after the motorcycle comes to a stop.<

The control unit can administer four sensors, so two different sets of wheels with RDC sensors can be alternated on the motorcycle. An error message is issued if wheels without sensors are fitted to a motorcycle equipped with an RDC control unit.

Temperature compensation

Tyre pressure is a temperature-sensitive variable: pressure increases as tyre temperature rises and decreases as tyre temperature drops. Tyre temperature depends on ambient temperature, on the style of riding and the duration of the ride.

The tyre-pressure readings shown by the multifunction display are temperature-compensated; the reference tyre temperature for these readings is always 20 °C. The air lines available to the public in petrol stations and motorway service areas have gauges that do not compensate for temperature; the reading shown by a gauge of this nature is the temperature-dependent tyre pressure. In most instances, therefore, these gauge readings will not tally with the pressures shown by the multifunction display.<

Tyre-pressure ranges

The RDC control unit differentiates between three tyre-pressure ranges, all of which are parameterised for the motorcycle:

- Tyre pressure within permitted tolerance.
- Tyre pressure close to limit of permitted tolerance.
- Tyre pressure outside permitted tolerance.

tyre pressure by the 0.2 bar difference between the value in the table and the RDC reading; when the air-line gauge shows 2.6 bar, the tyre is inflated to the correct pressure.<

A warning is also issued if tyre pressure drops sharply but stays within the permitted tolerance.

Pressure adaptation

Compare the RDC readings on the multifunction display with the value in the table on the inside cover of the Rider's Manual. Then use the air line to compensate for the difference between the RDC reading and the value in the table.

Example: According to the Rider's Manual, tyre pressure should be 2.5 bar, but the reading in the multifunction display is 2.3 bar. The gauge on the air line shows 2.4 bar. You must now increase

Engineering details

70

6

Accessories

General instructions.....	72
Power sockets	72
Luggage	73
Case.....	73
topcase	76

General instructions

BMW Motorrad recommends the use of parts and accessories for your motorcycle that are approved by BMW for this purpose. Genuine BMW parts and accessories and other products which BMW has approved can be obtained from your authorised BMW Motorrad dealer, together with expert advice on their installation and use.

These parts and products have been tested by BMW for safety, function and suitability. BMW accepts product liability for them. Conversely, BMW is unable to accept any liability whatsoever for parts and accessories which it has not approved.

Also bear in mind the information on the effect of wheel size on suspension-control systems (➡ 91).



BMW Motorrad cannot examine or test each product of outside origin to ensure that it can be used on or in connection with BMW motorcycles without constituting a safety hazard. Country-specific official authorisation does not suffice as assurance. Tests conducted by these instances cannot make provision for all operating conditions experienced by BMW motorcycles and, consequently, they are not sufficient in some circumstances. Use only parts and accessories approved by BMW for your motorcycle. ◀

Whenever you are planning modifications, comply with all the legal requirements. Make sure that the motorcycle does not infringe the national road-vehicle construction and use regulations applicable in your country.

Power sockets

Notes on use of power sockets:

automatic shutdown

Power sockets are shut down automatically under the following circumstances:

- If battery charge state is too low to maintain the motorcycle's start capability
- If maximum load capability as stated in the technical data is exceeded
- When the engine is being cranked on the starter

Operating electrical accessories

You can start using electrical accessories only when the ignition is switched on. The accessory remains operational if the ignition is subsequently switched off. The power sockets are switched off approximately 15 minutes after the ignition is switched off,

in order to prevent overloading of the on-board electrics.

Cable routing

The cables from the power sockets to the auxiliary devices must be routed in such a way that they:

- Do not impede the rider
- Do not restrict the steering angle or obstruct handling
- Cannot be trapped

Luggage

Lashing luggage

- Remove the seat (➡ 51).



- Pull luggage strap **1** through underneath the seat in the vicinity **2** of the filler neck of the fuel tank. Make sure that the strap is in front of the ribs on the underside of the seat.
- Install the seat (➡ 51).
- Position the luggage strap appropriately to hold the item of luggage and route it to the rear.

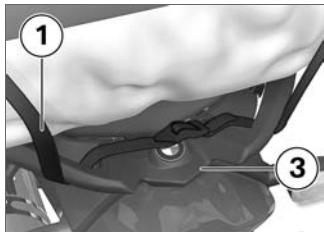

- Pass luggage strap **1** through grab handles **3** and pull it tight.
- Check that the luggage is secure.

Case

- with case^{OA}

Opening cases



- Turn the lock barrel to the OPEN position.



- Pull the grey release lever **1** (OPEN) up.
» Lock straps **2** open.

- Pull the grey release lever (OPEN) up again and simultaneously pull case lid **3** out of the retainer.

Closing cases

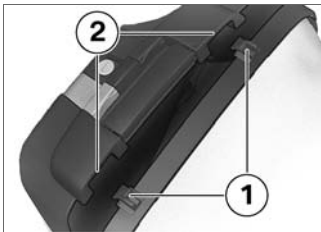

- Press catches **1** of the case lid into retainers **2** until they snap closed.

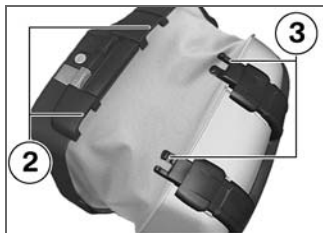

- Also press catches **3** of the lock straps into retainers **2** until they engage.

Adjusting case volume

- Close only the lid of the case.



- Push lock straps **1** out and pull them up.
» This expands the case to maximum volume.



- Close the lock straps.

- Press the case lid against the case body.
» The case volume adapts to the contents.

Removing cases



- Turn the lock barrel to the RELEASE position.

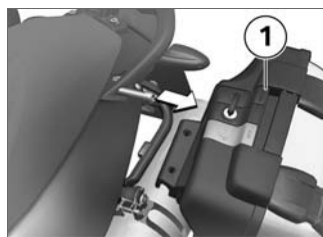

- Pull the black release lever **1** (RELEASE) up and simultaneously pull the case out.
- Then lift the case out of the bottom holder.

Installing cases

- Hook the case into the bottom holder.

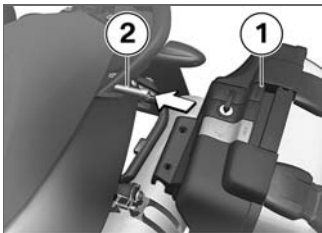

- Pull the black release lever **1** (RELEASE) up and simultaneously push the case into the upper holder **2**.
- Push the black release lever (RELEASE) down until it engages.
- Turn the key in the case lock in line with the forward direction of travel and remove the key from the lock.

Secure attachment



If a case wobbles or is difficult to fit, it has to be adapted to the gap between the top and bottom holders.

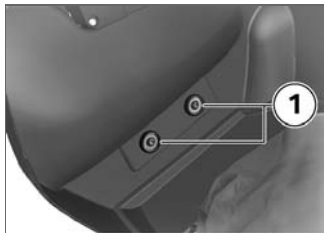

Screws **1** inside the case allow you to make this adjustment.

topcase

– with topcase^{OA}

Opening topcase



- Turn the key to the OPEN position in the topcase lock.

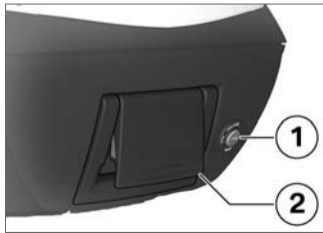

- Push lock barrel **1** forward.
» Lever **2** pops up.

- Pull the release lever all the way up.
» The lid of the topcase opens.

Close the topcase



- Pull release lever **2** all the way up.
- Close the lid of the topcase and hold it down. Check that nothing is trapped between the lid and the case.



- Push release lever **2** down until it engages.
- Turn the key in the topcase lock to the LOCK position and remove the key from the lock.

Removing topcase



- Turn the key to the RELEASE position in the topcase lock.
» The handle pops out.



- Pull handle **3** up as far as it will go.

- Lift the topcase at the rear and remove it from the luggage carrier.

Installing topcase

- Pull the handle up as far as it will go.



- Hook the topcase into position on the luggage carrier. Make sure that hooks **4** are securely seated in the corresponding keepers **5**.



- Push handle **3** down until it engages.
- Turn the key in the topcase lock to the LOCK position and remove the key from the lock.

Maintenance

General instructions.....	80
Toolkit	80
Engine oil	81
Brake system	82
Coolant	87
Clutch	87
Rims and tyres.....	88
Chain	89
Wheels	91
Front-wheel stand	97
Bulbs	98
Body panels	104
Jump starting	106
Battery.....	107

General instructions

The "Maintenance" chapter describes straightforward procedures for checking and replacing certain wear parts.

Special tightening torques are listed as applicable. The tightening torques for the threaded fasteners on your motorcycle are listed in the section entitled "Technical data".

You will find information on more extensive maintenance and repair work in the Repair Manual on DVD for your motorcycle, which is available from your authorised BMW Motorrad dealer.

Some of the work calls for special tools and a thorough knowledge of motorcycle technology. If you are in doubt consult a specialist workshop, preferably your authorised BMW Motorrad dealer.

Toolkit

Standard toolkit

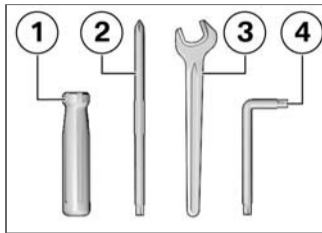

1 Screwdriver handle

- 2 Reversible screwdriver blade
With star-head and Torx T25
- Replacing turn indicator bulbs, front and rear (➡ 103).
 - Replacing the brake light and rear light bulbs (➡ 102).
 - Removing battery (➡ 109).
 - Removing body panels
- 3 Open-ended spanner
Width across flats 17
- Adjust the mirror arm (➡ 47).
- 4 Torx wrench, T40
- Adjusting headlight beam throw (➡ 50).

Tools service set

- with service toolkit^{OA}

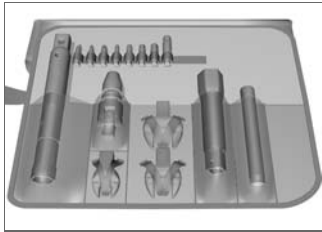

BMW Motorrad has assembled a tools service set that is ideal for carrying out extended service work (e.g. removing and installing wheels) on this motorcycle. You can obtain the tools set from your authorised BMW Motorrad dealer.

Engine oil

Checking engine oil level

 The engine can seize if the oil level is low, and this can lead to accidents.

Always make sure that the oil level is correct.◀

 The oil level varies with the temperature of the oil. The higher the temperature, the higher the level of oil in the sump. Checking the oil level with the engine cold or after no more than a short ride will lead to misinterpretation; this in turn, means that the engine will be operated with the incorrect quantity of oil. In order to ensure that the engine oil level is read correctly, check the oil level only after a lengthy trip.◀

- Wipe the area around the oil filler neck clean.
- Allow the engine to idle until the fan starts up, then allow it to idle one minute longer.
- Switch off the engine.
- Make sure the engine is at operating temperature and hold the motorcycle upright.
 - with centre stand^{OA}
- Check that the engine is at operating temperature, make sure

the ground is level and firm and place the motorcycle on its centre stand.◀

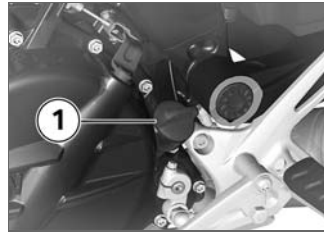

- Remove oil dipstick **1**.

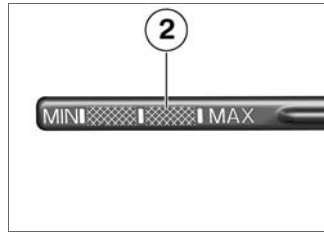

- Use a dry cloth to wipe gauge length **2** clean

- Seat the oil dipstick on the oil filler neck, but do not engage the threads.
- Remove the oil dipstick and check the oil level.

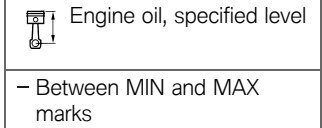
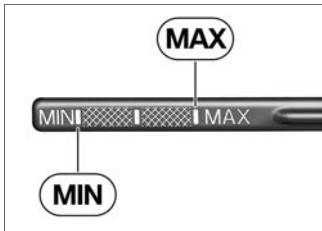

If the oil level is below the MIN mark:

- Top up the engine oil (➡ 82).

If the oil level is above the MAX mark:

- Have the oil level corrected by a specialist workshop, preferably an authorised BMW Motorrad dealer.

- Install the oil dipstick.

Topping up engine oil

- Make sure the ground is level and firm and place the motorcycle on its stand.
- Wipe the area around the filler neck clean.

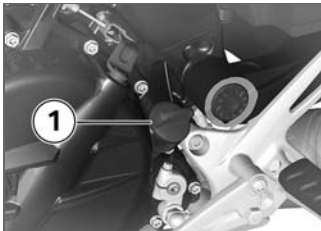

- Remove oil dipstick **1**.



Damage to the engine can result if it is operated without enough oil, but the same also applies if the oil level is too high.

Always make sure that the oil level is correct. ◀

- Top up the engine oil to the specified level.
- Checking engine oil level (➡ 81).
- Install the oil dipstick.

Brake system

Check operation of the brakes

- Pull the handbrake lever.
 - » The pressure point must be clearly perceptible.
- Press the footbrake lever.
 - » The pressure point must be clearly perceptible.

If pressure points are not clearly perceptible:

 Incorrect working practices endanger the reliability of the brakes.

Have all work on the brake system undertaken by trained and qualified specialists. ◀

- Have the brakes checked by a specialist workshop, preferably an authorised BMW Motorrad dealer.

Check the front brake pad thickness

- Make sure the ground is level and firm and place the motorcycle on its stand.



- Visually inspect the left and right brake pads to ascertain their thickness. Viewing direction: between wheel and front suspension toward brake calipers **1**.

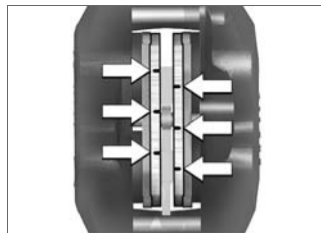

 Brake-pad wear limit, front

- min 1.0 mm (Friction pad only, without backing plate. The wear indicators (grooves) must be clearly visible.)

If the wear indicating marks are no longer clearly visible:

 Brake pads worn past the minimum permissible thickness can cause a reduction in braking efficiency and under certain circumstances they can

cause damage to the brake system.

In order to ensure the dependability of the brake system, do not permit the brake pads to wear past the minimum permissible thickness.◀

- Have the brake pads replaced by a specialist workshop, preferably an authorised BMW Motorrad dealer.

Checking rear brake pad thickness

- Make sure the ground is level and firm and place the motorcycle on its stand.



- Visually inspect the brake pads to ascertain their thickness. Viewing direction: from the rear toward brake caliper **1**.

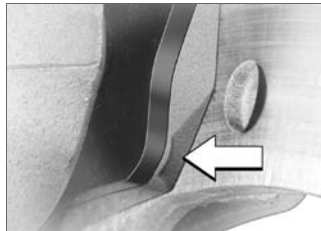

Brake-pad wear limit,
rear

- min 1.0 mm (Friction pad only, without backing plate. The wear indicators must be clearly visible.)

If the wear indicating mark is no longer visible:



Brake pads worn past the minimum permissible thickness can cause a reduction in braking efficiency and under certain circumstances they can

cause damage to the brake system.

In order to ensure the dependability of the brake system, do not permit the brake pads to wear past the minimum permissible thickness.◀

- Have the brake pads replaced by a specialist workshop, preferably an authorised BMW Motorrad dealer.

Check the brake-fluid level, front brakes

 A low fluid level in the brake reservoir can allow air to penetrate the brake system. This significantly reduces braking efficiency.

Check the brake-fluid level at regular intervals.◀

- Make sure the ground is level and firm and hold the motorcycle upright.

- with centre stand^{OA}
- Make sure the ground is level and firm and place the motorcycle on its centre stand.◀
- Move the handlebars to the straight-ahead position.



- Check the brake fluid level in front reservoir **1**.

 Wear of the brake pads causes the brake fluid level in the reservoir to sink.◀



Brake fluid level, front
(visual inspection)

– DOT4 brake fluid

– Do not permit the brake fluid level to drop below the MIN mark.

If the brake fluid level drops below the permitted level:

- Have the defect rectified as quickly as possible by a specialist workshop, preferably an authorised BMW Motorrad dealer.

Check the brake-fluid level, rear brakes

 A low fluid level in the brake reservoir can allow air to penetrate the brake system. This significantly reduces braking efficiency.

Check the brake-fluid level at regular intervals. ◀

- Make sure the ground is level and firm and hold the motorcycle upright.
 - with centre stand^{OA}
- Make sure the ground is level and firm and place the motorcycle on its centre stand. ◀



- Check the brake fluid level in rear reservoir **1**.

 Wear of the brake pads causes the brake fluid level in the reservoir to sink. ◀



 Brake fluid level, rear (visual inspection)

– DOT4 brake fluid

– Do not permit the brake fluid level to drop below the MIN mark.

If the brake fluid level drops below the permitted level:

- Have the defect rectified as quickly as possible by a specialist workshop, preferably an authorised BMW Motorrad dealer.

Coolant

Checking coolant level

- Make sure the ground is level and firm and place the motor-cycle on its stand.

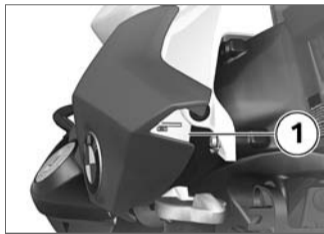

- Check the coolant level in expansion tank **1**. Viewing direction: from in front through the opening in the side panel to the expansion tank.



 Minimum quantity of coolant

- do not permit the fluid level to drop below the MIN mark on the expansion tank

If the coolant drops below the permitted level:

- Top up the coolant.

Topping up coolant

- Remove the right side panel (➔ 105).



- Open cap **1** of the expansion tank.
- Top up coolant to specified level.
- Close the cap of the expansion tank.
- Install the right side panel (➔ 106).

Clutch

Checking clutch operation

- Pull the clutch lever.
 - » The pressure point must be clearly perceptible.

If the pressure point is not clearly perceptible:

- Have the clutch checked by a specialist workshop, preferably an authorised BMW Motorrad dealer.

Check the clutch play

- Turn the handlebars all the way to left

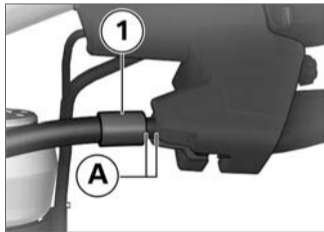

- Pull clutch cable **1** as far as possible away from the clutch lever.

- Measure clutch play **A** between the handlebar fitting and the clutch cable.

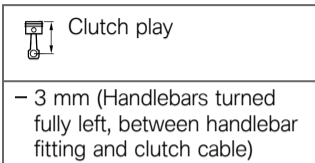

Clutch play is out of tolerance:

- Adjusting clutch play (→ 88).

Adjusting clutch play

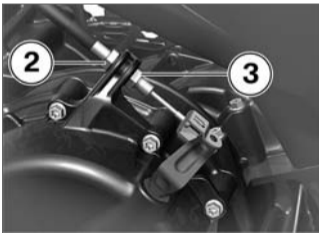

- Slacken nut **3**.
- To increase clutch play: screw nut **2** up.

- To reduce clutch play: screw nut **2** down.
- Check the clutch play (→ 88).
- Repeat the steps in this procedure until clutch play is set correctly.
- Tighten nut **3**.

Rims and tyres

Checking rims

- Make sure the ground is level and firm and place the motorcycle on its stand.
- Visually inspect the rims for defects.
- Have damaged rims checked and, if necessary, replaced by a specialist workshop, preferably an authorised BMW Motorrad dealer.

Check the tyre tread depth

 Your motorcycle's handling and grip can be impaired even before the tyres wear to the minimum tyre tread depth permitted by law.

Have the tyres changed in good time before they wear to the minimum permissible tread depth. ◀

- Make sure the ground is level and firm and place the motorcycle on its stand.
- Measure the tyre tread depth in the main tread grooves with wear marks.

 Tyres have wear indicators integrated into the main tread grooves. The tyre is worn out when the tyre tread has worn down to the level of the marks. The locations of the marks are indicated on the edge of the tyre,

e.g. by the letters TI, TWI or by an arrow. ◀

If the tyre tread is worn to minimum:

- Replace tyre or tyres, as applicable.

Chain

Lubricating chain

 Dirt, dust and inadequate lubrication will result in accelerated wear and significantly shorten the drive chain's useful life.

Clean and lubricate the drive chain at regular intervals. ◀

- Lubricate the drive chain every 1000 km at the latest. Lubricate the chain more frequently if the motorcycle is ridden in wet, dusty or dirty conditions. ◀
- Switch the ignition off and select neutral.

- Clean the drive chain with a suitable cleaning product, dry it and apply chain lubricant.
- Wipe off excess lubricant.

Checking chain sag

- Make sure the ground is level and firm and place the motorcycle on its stand.
- Turn the rear wheel until it reaches the position with the lowest amount of chain sag.

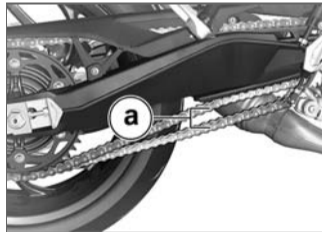

- Use a screwdriver to push the chain up and down and measure difference **a**.



Chain deflection

- 30...40 mm (Motorcycle with no weight applied, supported on its side stand)

If measured value is outside permitted tolerance:

- Adjust the chain sag (→ 90).

Adjust the chain sag

- Make sure the ground is level and firm and place the motorcycle on its stand.

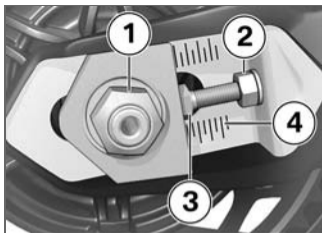

- Slacken quick-release axle nut **1**.
- Slacken locknuts **2** on left and right.
- Use adjusting screws **3** on left and right to adjust chain sag.
- Checking chain sag (→ 89).
- Make sure that scale readings **4** are the same on left and right.
- Tighten locknuts **2** on left and right.



Locknut of the final-drive chain tensioning screw

- 19 Nm

- Tighten quick-release axle nut **1** to the specified tightening torque.



Rear quick-release axle in swinging arm

- 100 Nm

Checking chain wear

- Make sure the ground is level and firm and place the motorcycle on its stand.

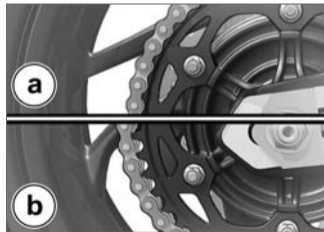

Accelerated wear.
If a component of the sprocket with mounting parts is

found to be worn, the entire set has to be replaced.◀

- Pull the chain back at the rear-most point of the sprocket.
 - » The top of the teeth are still between the chain links (**a**): the chain is OK.
 - » The chain is being pulled out over the top of the teeth (**b**): contact a specialist workshop, preferably an authorised BMW Motorrad dealer.

Wheels

Tyre recommendation

For each size of tyre BMW Motorrad tests certain makes, and approves those that it certifies as roadworthy. If BMW Motorrad has not approved the wheels and tyres, it cannot assess their suitability or provide any guarantee of road safety.

Use only wheels and tyres approved by BMW Motorrad for your type of motorcycle. You can obtain detailed information from your authorised BMW Motorrad dealer or on the Internet at www.bmw-motorrad.com.

Effect of wheel size on ABS

Wheel size is very important as a parameter for the ABS. In particular, the diameter and the width of a motorcycle's wheels are programmed into the control unit and are fundamental to all calculations. Any change in these influencing variables, caused for example by a switch to wheels other than those installed ex-works, can have serious effects on the performance of the control systems.

The sensor rings are essential for correct road-speed calculation, and they too must match

the motorcycle's control systems and consequently cannot be changed.

If you decide that you would like to fit non-standard wheels to your motorcycle, it is very important to consult a specialist workshop beforehand, preferably an authorised BMW Motorrad dealer. In some cases, the data programmed into the control units can be changed to suit the new wheel sizes.

RDC label

- with tyre pressure monitoring (RDC)^{OE}



! Incorrect tyre fitting can damage the RDC sensors. Be sure to explain to the authorised BMW Motorrad dealer or the specialist workshop that the wheel is fitted with an RDC sensor. ◀

If the motorcycle is equipped with RDC, each wheel rim bears an adhesive label indicating the position of the RDC sensor. When changing the tyre, take care not to damage the RDC sensor. Be sure to draw the attention of the authorised BMW Motorrad dealer or specialist

workshop to the fact that the wheel is fitted with an RDC sensor.

Removing front wheel

- Make sure the ground is level and firm and place the motorcycle on its stand.
- with BMW Motorrad ABS^{OE}



- Remove screw **1** and remove the speed sensor from its bore. ◀



! Once the calipers have been removed, there is a risk of the brake pads being pressed together to the extent that they cannot be slipped back over the brake disc on reassembly.

Do not operate the handbrake lever when the brake calipers have been removed. ◀

- Remove screws **2** of the brake calipers on left and right.

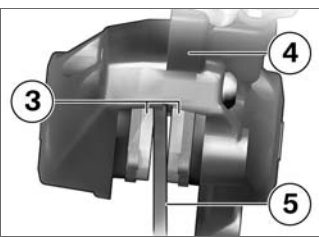

- Force the brake pads **3** slightly apart by rocking brake caliper **4** back and forth against brake disc **5**.

- Mask off the parts of the wheel rim that could be scratched in the process of removing the brake calipers.

- Carefully pull the brake calipers back and out until clear of the brake discs.

- Make sure the ground is level and firm and place the motorcycle on a suitable auxiliary stand.

- with centre stand^{OA}
- Make sure the ground is level and firm and place the motorcycle on its centre stand.◀

- Raise front of motorcycle until the front wheel can turn freely. BMW Motorrad recommends the BMW Motorrad front-wheel stand for lifting the motorcycle.

- Install the front-wheel stand (→ 97).



- Slacken axle clamping screws **1**.
- Remove quick-release axle **2**, while supporting the wheel.

- Roll the front wheel forward to remove.

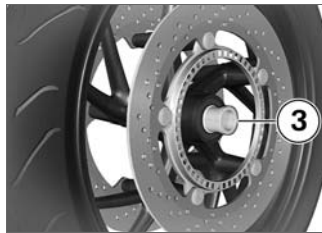

- Remove spacing bushing **3** from the left-hand side of the wheel hub.

Installing front wheel

⚠ Threaded fasteners not tightened to the specified torque can work loose or their threads can suffer damage.

Always have the security of the fasteners checked by a specialist workshop, preferably an authorised BMW Motorrad dealer.◀

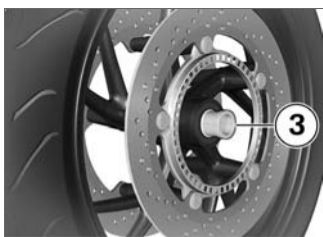

- Slip spacing bushing **3** onto the left-hand side of the wheel hub.

 The front wheel must be installed right way round to rotate in the correct direction. Note the direction-of-rotation arrows on the tyre or the wheel rim. ◀

- Roll the front wheel into position between the front forks.

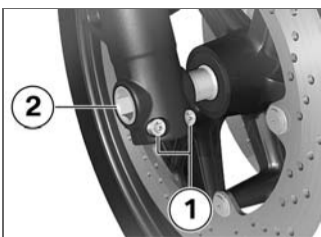

- Raise the front wheel, insert quick-release axle **2** and tighten to specified torque.



Quick-release axle in fork leg

– 50 Nm

- Tighten axle clamping screws **1** to the specified tightening torque.



Clamp of quick-release axle

– 20 Nm

- Remove the front-wheel stand.

- without centre stand^{OA}
- Remove the auxiliary stand. ◀
- Ease the brake calipers on to the brake discs.



- Tighten screws **2** of the brake calipers on left and right to the specified torque.



Brake caliper on fork leg

– 30 Nm

- Remove the adhesive tape from the wheel rim.

- Operate the brake several times until the brake pads are bedded.

– with BMW Motorrad ABS^{OE}



- Insert the speed sensor into the bore and install screw **1**.◁

Remove the rear wheel



- Remove screw **1** and remove the speed sensor from its bore.
- Make sure the ground is level and firm and place the motorcycle on a suitable auxiliary stand.

– with centre stand^{OA}

- Make sure the ground is level and firm and place the motorcycle on its centre stand.◁

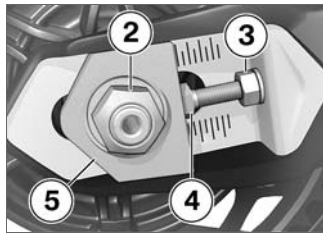

- Remove axle nut **2**.
- Slacken locknuts **3** on left and right.
- Slacken adjusting screws **4** on left and right.
- Remove adjusting plate **5** and push the axle in as far as it will go.

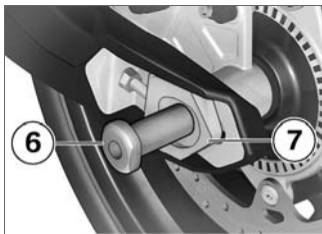

- Remove quick-release axle **6** and remove adjusting plate **7**.



- Roll the rear wheel as far forward as possible and disengage chain **8** from the sprocket.

- Roll the rear wheel back until it is clear of the swinging arm.

▶ The sprocket and the spacer sleeves on left and right are loose fits in the wheel. Make sure that these parts are not damaged or lost on removal. ◀

Installing rear wheel

⚠ Threaded fasteners not tightened to the specified torque can work loose or their threads can suffer damage. Always have the security of the fasteners checked by a specialist workshop, preferably an authorised BMW Motorrad dealer. ◀

- Roll the rear wheel into the swinging arm, making sure that the brake disc passes between the brake pads.

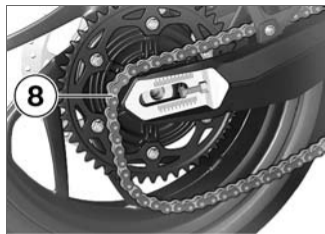

- Roll the rear wheel as far forward as possible and loop chain **8** over the sprocket.



- Seat left adjusting plate **7** in the swinging arm and install quick-release axle **6** in the

brake caliper and the rear wheel.

- Make sure that the axle fits into the recess of the adjusting plate.

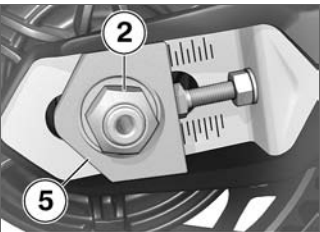

- Install right adjusting plate **5**.
- Install nut **2**, but do not tighten it at this point.

- without centre stand^{OA}
- Remove the auxiliary stand.<



- Insert the speed sensor into the bore and install screw **1**.
- Adjust the chain sag (➡ 90).

Front-wheel stand

Installing front-wheel stand

 The BMW Motorrad front wheel stand is not designed to support the motorcycle without the assistance of an auxiliary stand. A motorcycle resting only on the front wheel stand and the rear wheel can topple.

Place the motorcycle on an auxiliary stand before lifting the front wheel with the BMW Motorrad front-wheel stand.<

- Make sure the ground is level and firm and place the motorcycle on a suitable auxiliary stand.
- with centre stand^{OA}
- Make sure the ground is level and firm and place the motorcycle on its centre stand.<

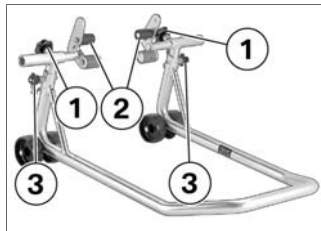

- Use basic stand (0 402 241) with front-wheel adapter (0 402 242).

- Slacken adjusting screws **1**.
- Push the two adapters **2** apart until the front forks fit between them. Adjust the adapter studs to suit the front suspension.
- Use locating pins **3** to set the front-wheel stand to the desired height.
- Centre the front-wheel stand relative to the front wheel and push it against the front axle.

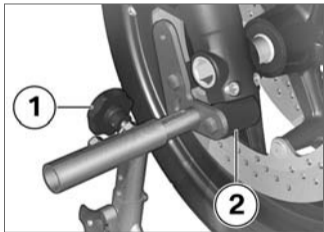

- Align the two adapters **2** so that the front forks are securely seated.
- Tighten adjusting screws **1**.



- Apply uniform pressure to push the front-wheel stand down and raise the motorcycle.

– with centre stand^{OA}

! If the motorcycle is raised too far the centre stand will lift clear of the ground and the motorcycle could topple to one side.

When raising the motorcycle, make sure that the centre stand remains on the ground. If necessary, adjust the height of the front-wheel stand.◀

- Make sure the motorcycle is standing firmly.◀

Bulbs

General instructions

A warning appears in the multi-function display if a bulb is defective.

! A defective bulb places your safety at risk because it is easier for other users to oversee the motorcycle. Replace defective bulbs as soon as possible; always carry a complete set of spare bulbs if possible.◀

! The bulb is pressurised and can cause injury if damaged.

Wear protective goggles and gloves when changing bulbs.◀

▶ The types of bulb fitted to your motorcycle are listed

in the section entitled "Technical data". ◀

Replacing low-beam and high-beam headlight bulb

- Make sure the ground is level and firm and place the motorcycle on its stand.
- Switch off the ignition.

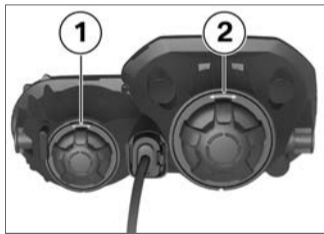

- Remove cover **1** for the high-beam headlight or cover **2** for the low-beam headlight.

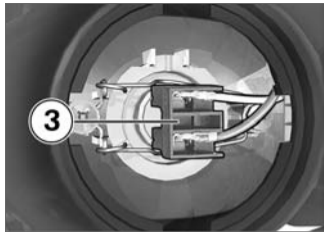

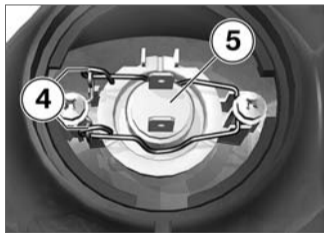

- Disconnect plug **3**.



- Disengage spring clips **4** from the fastenings and swing them aside.
- Remove bulb **5**.

- Replace the defective bulb.

▶ Do not touch the glass of new bulbs with your fingers. Use a clean, dry cloth to hold the bulbs when handling them. Dirt deposits, in particular oil and grease, interfere with heat radiation from the bulb. This leads to overheating and shortens the bulb's operating life. ◀

	Bulb for high-beam headlight
- H7 / 12 V / 55 W	
	Bulbs for the low-beam headlight
- H7 / 12 V / 55 W	

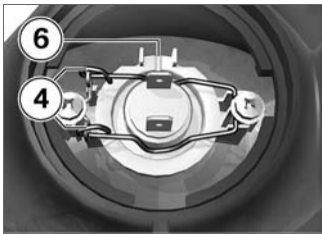

- Install the bulb, making sure that alignment is correct at position **6**.
- Close and lock spring clips **4**.

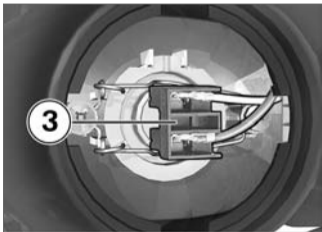

- Connect plug **3**.

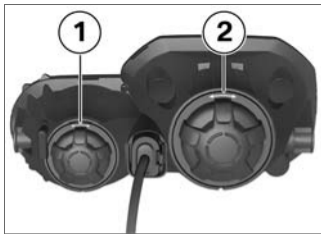

- Install cover **1** or cover **2**, as applicable.

Replacing parking-light bulb

- Make sure the ground is level and firm and place the motorcycle on its stand.
- Switch off the ignition.

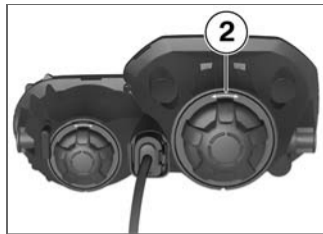

- Remove cover **2**.

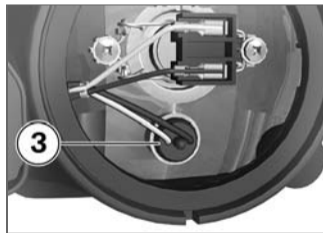

- Pull parking-light bulb **3** out of the headlight housing.



Bulb for parking light

– W5W / 12 V / 5 W



- Push the bulb into the bulb socket.

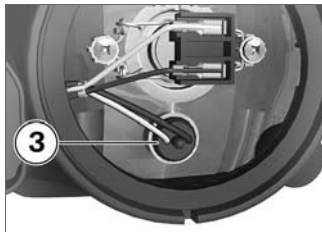

- Insert parking-light bulb **3** into the headlight housing.

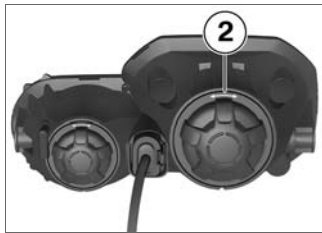

- Install cover **2**.

- Remove the bulb from the bulb holder.

- Replace the defective bulb.



Do not touch the glass of new bulbs with your fingers.

Use a clean, dry cloth to hold the bulbs when handling them. Dirt deposits, in particular oil and grease, interfere with heat radiation from the bulb. This leads to overheating and shortens the bulb's operating life. ◀

Replacing the brake light and rear light bulbs

- Make sure the ground is level and firm and place the motorcycle on its stand.
- Switch off the ignition.

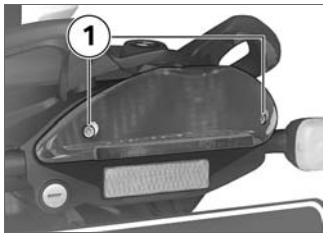

- Remove screws **1**.
- Pull the bulb housing to the rear to remove.

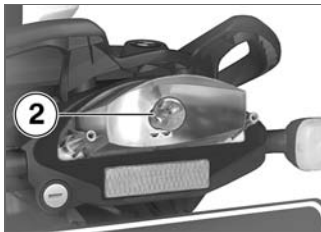

- Remove bulb **2**.
- Replace the defective bulb.



Bulb for tail light/brake light

– P21/5W / 12 V / 5 W / 21 W

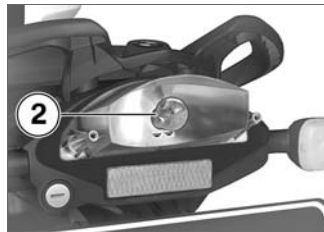

- Install bulb **2**.

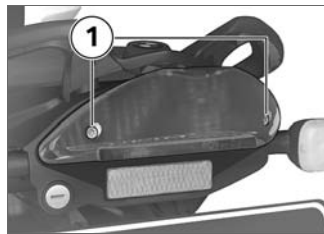

- Hold the bulb housing in position and install screws **1**.

Replacing turn indicator bulbs, front and rear

- Make sure the ground is level and firm and place the motorcycle on its stand.
- Switch off the ignition.



- Remove screw **1**.

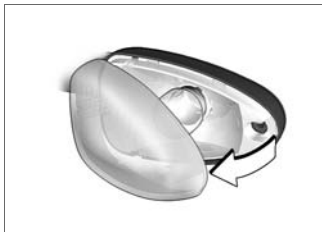

- Pull the glass out of the reflector housing at the threaded-fastener side.

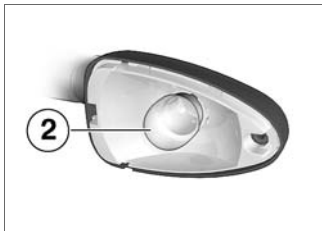

- Turn bulb **2** counter-clockwise and remove it from the bulb housing.

- Replace the defective bulb.

Do not touch the glass of new bulbs with your fingers. Use a clean, dry cloth to hold the bulbs when handling them. Dirt deposits, in particular oil and grease, interfere with heat radiation from the bulb. This leads to overheating and shortens the bulb's operating life.◀



Bulbs for flashing turn indicators, front

– R10W / 12 V / 10 W

– with white turn indicators^{OE}

– RY10W / 12 V / 10 W◀

– with LED turn indicators^{OE}

– LED / 12 V◀

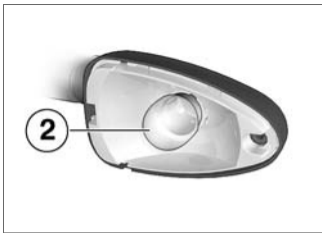

- Turn bulb **2** clockwise to install it in the bulb housing.

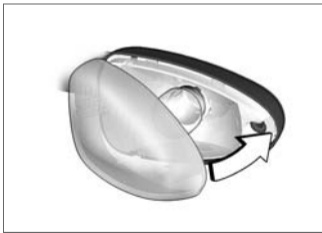

- Working from the inboard side, insert the glass into the bulb housing and close the housing.



- Install screw **1**.

Body panels

Removing centre trim panel

- Remove the seat (➔ 51).

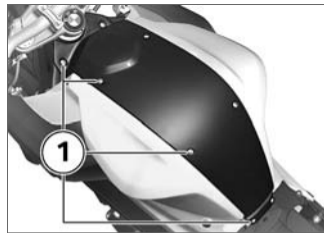

- Remove four screws **1** on left and right and remove the centre trim panel.

Installing centre trim panel



- Slip the centre trim panel underneath the left and right side panels at position **2** and then seat it in guides **3** on left and right.

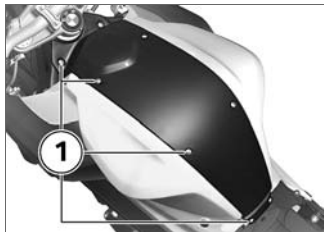

- Install four screws **1** on left and right.
- Install the seat (➔ 51).

Remove the right side panel

- Remove the centre trim panel (➔ 104).

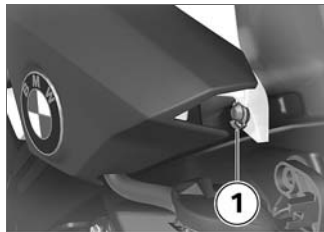

- Remove circlip **1**.

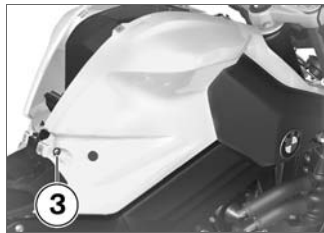

- Remove screw **3**.
- Raise the side panel slightly at the rear and then work it to the side to remove.

Install the right side panel

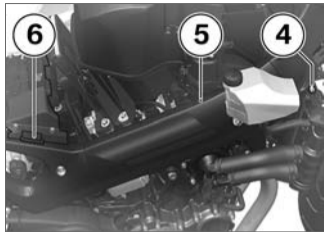

- Begin by positioning the side panel on retaining pin **4**, then swing it down and snap it into mounts **5** and **6**.

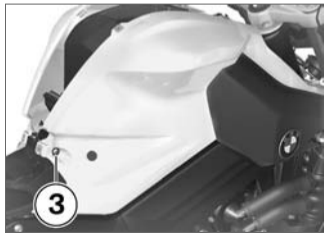

- Install screw **3**.

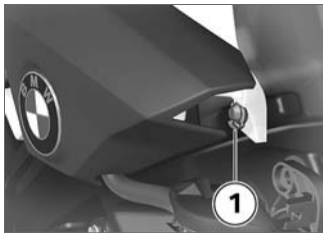

- Install circlip **1**.
- Install the centre trim panel (➔ 105).

Jump starting

⚠ The wires leading to the power socket do not have a load-capacity rating adequate for jump-starting the engine. Excessively high current can lead to a cable fire or damage to the vehicle electronics.

Do not use the on-board socket to jump-start the engine of the motorcycle. ◀

⚠ A short-circuit can result if the crocodile clips of the jump leads are accidentally brought into contact with the motorcycle.

Use only jump leads fitted with fully insulated crocodile clips at both ends. ◀

⚠ Jump-starting with a donor-battery voltage higher than 12 V can damage the vehicle electronics.

Make sure that the battery of the donor vehicle has a voltage rating of 12 V. ◀

- Remove the centre trim panel (➔ 104).
- When jump-starting the engine, do not disconnect the battery from the on-board electrical system.

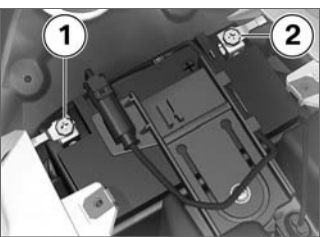

- Begin by connecting one end of the red jump lead to the positive terminal of the discharged battery and the other end to the positive terminal of the donor battery (positive on this vehicle: position **2**).
- Then connect one end of the black jump lead to the negative terminal of the donor battery and the other end to the negative terminal of the discharged battery (negative on this vehicle: position **1**).

 The spring-strut screw can be used as an alternative to the battery's negative terminal. ◀

- Run the engine of the donor vehicle during jump-starting.
- Start the engine of the vehicle with the discharged battery in the usual way; if the engine does not start, wait a few minutes before repeating the attempt in order to protect the starter motor and the donor battery.
- Allow both engines to idle for a few minutes before disconnecting the jump leads.
- Disconnect the jump lead from the negative terminals first, then disconnect the second lead from the positive terminals.

 Do not use proprietary start-assist sprays or other products to start the engine. ◀

- Install the centre trim panel (➡ 105).

Battery

Maintenance instructions

Correct upkeep, recharging and storage will prolong the life of the battery and are essential if warranty claims are to be considered.

Compliance with the points below is important in order to maximise battery life:

- Keep the surface of the battery clean and dry
- Do not open the battery
- Do not top up with water
- Be sure to read and comply with the instructions for charging the battery on the following pages
- Do not turn the battery upside down

 If the battery is not disconnected, the on-board electronics (e.g. clock, etc.) gradually drain the battery. This can cause the battery to run flat. If this happens, warranty claims will not be accepted.

If the motorcycle is to be out of use for more than four weeks, disconnect the battery or connect a suitable trickle charger to the battery. ◀

 BMW Motorrad has developed a float charger specially designed for compatibility with the electronics of your motorcycle. Using this charger, you can keep the battery charged during long periods of disuse, without having to disconnect the battery from the motorcycle's on-board systems. You can obtain additional information from your authorised BMW Motorrad dealer. ◀

Charging battery when connected

 Charging the connected battery directly at the battery terminals can damage the vehicle electronics.

Always disconnect the battery from the on-board circuits before recharging it with a charger connected directly to the battery posts. ◀

 Only chargers suitable for this mode of charging can be used to recharge the battery via the on-board socket. Unsuitable chargers could cause damage to the motorcycle's on-board electrics.

Use BMW chargers with the part numbers 71 60 7 688 864 (220 V) or, as applicable, 71 60 7 688 865 (110 V). If you are in doubt, disconnect the battery from the on-board

systems and connect the charger directly to the battery. ◀

 If you switch on the ignition and the multifunction display and telltale lights fail to light up, the battery is completely flat. Attempting to charge a completely flat battery via the on-board socket can cause damage to the motorcycle's electronics. If a battery has discharged to the extent that it is completely flat, it has to be disconnected from the on-board circuits and charged with the charger connected directly to the battery posts. ◀

- Charge via the power socket, with the battery connected to the motorcycle's on-board electrical system.

 The motorcycle's on-board electronics know when the battery is fully charged. The on-board socket is switched off when this happens. ◀

- Comply with the operating instructions of the charger.

▷ If you are unable to charge the battery through the on-board socket, you may be using a charger that is not compatible with your motorcycle's electronics. If this happens, disconnect the battery from the on-board systems and connect the charger directly to the battery.◀◀

Charging battery when disconnected

- Charge the battery using a suitable charger.
- Comply with the operating instructions of the charger.
- Once the battery is fully charged, disconnect the charger's terminal clips from the battery terminals.

▷ The battery has to be recharged at regular intervals in the course of a lengthy period

of disuse. See the instructions for caring for your battery. Always fully recharge the battery before restoring it to use◀

Removing battery

- Make sure the ground is level and firm and place the motorcycle on its stand.
 - with anti-theft alarm^{OE}
- If applicable, switch off the anti-theft alarm.◀
- Switch off the ignition.
- Remove the centre trim panel (➡ 104).

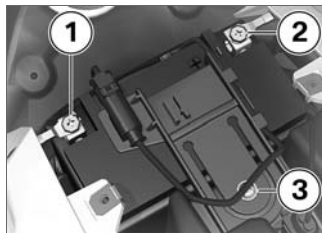

⚠ Disconnection in the wrong sequence increases the risk of short-circuits.

Always proceed in the correct sequence.◀

- Disconnect negative lead **1** first.
- Then disconnect positive lead **2**.
- Remove screw **3** and remove the battery holder.
- Lift the battery up and out; work it slightly back and forth if it is difficult to remove.

Installing battery

▶ If the battery was disconnected from the motorcycle for a prolonged period of time it will be necessary to enter the current date in the instrument panel, in order to ensure that the service-due indicator functions correctly.

If you want to have the date set consult a specialist workshop, preferably an authorised BMW Motorrad dealer. ◀

- Switch off the ignition.
- Insert the battery into the battery compartment, with the positive terminal on the right in the direction of travel.

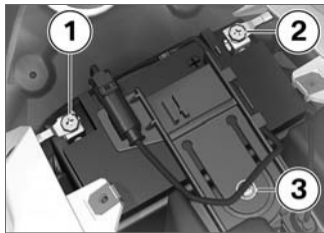

- Slip the battery holder over the battery and install screw **3**.

 Connection in the wrong sequence increases the risk of short-circuits.

Always proceed in the correct sequence. ◀

- Connect positive lead **2** to the battery's positive terminal.
- Connect negative lead **1** to the battery's negative terminal.
- Install the centre trim panel (➡ 105).
- Set the clock (➡ 39).

Care

Care products	112
Washing motorcycle	112
Cleaning easily damaged components.....	112
Paint care	113
Protective wax coating	114
Laying up motorcycle	114
Restoring motorcycle to use	114

Care products

BMW Motorrad recommends that you use the cleaning and care products you can obtain from your authorised BMW Motorrad dealer. The substances in BMW Care Products have been tested in laboratories and in practice; they provide optimised care and protection for the materials used in your vehicle.

 The use of unsuitable cleaning and care products can damage vehicle components. Do not use solvents such as cellulose thinners, cold cleaners, fuel or the like, and do not use cleaning products that contain alcohol.◀

Washing motorcycle

BMW Motorrad recommends that you use BMW insect remover to soften and wash off insects and stubborn dirt on

painted parts prior to washing the motorcycle.

To prevent stains, do not wash the motorcycle immediately after it has been exposed to strong sunlight and do not wash it in the sun.

Make sure that the motorcycle is washed frequently, especially during the winter months.

To remove road salt, clean the motorcycle with cold water immediately after every trip.

 After the motorcycle has been washed, ridden through water or ridden in the rain, the brake discs and pads might be wet and the brakes might not take effect immediately.

Apply the brakes in good time until the brake discs and brake pads have dried out.◀



Warm water intensifies the effect of salt.

Use only cold water to wash off road salt.◀



The high pressure of steam cleaners can damage seals, the hydraulic brake system, the electrical system, and the seat. Do not use a steam jet or high-pressure cleaning equipment.◀

Cleaning easily damaged components

Plastics

Clean plastic parts with water and BMW plastic care emulsion. This includes in particular:

- Windscreen and slipstream deflectors
- Headlight lens made of plastic
- Glass of the instrument panel
- Black, unpainted parts

 If plastic parts are cleaned using unsuitable cleaning agents, the surfaces can be damaged.

Do not use cleaning agents that contain alcohol, solvents or abrasives to clean plastic parts. Even fly-remover pads or cleaning pads with hard surfaces can produce scratches.◀

 Soften stubborn dirt and insects by covering the affected areas with a wet cloth.◀

Chrome

Use plenty of water and BMW shampoo to clean chrome, particularly if it has been exposed to road salt. Use chrome polish for additional treatment.

Radiator

Clean the radiator regularly to prevent overheating of the engine due to inadequate cooling. For example, use a garden hose with low water pressure.

 Cooling fins can be bent easily.

Take care not to bend the fins when cleaning the radiator.◀

Rubber

Treat rubber components with water or BMW rubber-care products.

 Using silicone sprays for the care of rubber seals can cause damage.

Do not use silicone sprays or other care products that contain silicon.◀

Paint care

Washing the motorcycle regularly will help counteract the long-term effects of substances that damage the paint, especially if your motorcycle is ridden in areas with high air pollution or natural sources of dirt, for example tree resin or pollen.

Remove particularly aggressive substances immediately, however, as otherwise the paint can be affected or become discoloured. Substances of this nature include spilt fuel, oil, grease, brake fluid and bird droppings. We recommend BMW vehicle polish or BMW paint cleaner for this purpose.

Marks on the paintwork are particularly easy to see after the motorcycle has been washed. Remove stains of this kind immediately, using cleaning-grade benzene or petroleum spirit on a clean cloth or ball of cotton wool.

BMW Motorrad recommends BMW tar remover for removing specks of tar. Remember to wax the parts treated in this way.

Protective wax coating

BMW Motorrad recommends applying only BMW car wax or products containing carnauba wax or synthetic wax.

It is time to rewax the paintwork when water "puddles" on the surface, instead of forming beads.

Laying up motorcycle

- Clean the motorcycle.
- Removing battery (➡ 109).
- Spray the brake and clutch lever pivots, the side stand pivots and the centre stand pivots (if the motorcycle is fitted with a centre stand) with a suitable lubricant.

- Coat bright metal and chrome-plated parts with an acid-free grease (e.g. Vaseline).
- Stand the motorcycle in a dry room in such a way that there is no load on either wheel.

▶ Before laying the vehicle up out of use, have the engine oil and the oil filter element changed by a specialist workshop, preferably an authorised BMW Motorrad dealer. Combine work for laying up/restoring to use with a BMW service or inspection.◀

Restoring motorcycle to use

- Remove the protective wax coating.
- Clean the motorcycle.
- Install a charged battery.
- Before starting: work through the checklist.

Technical data

troubleshooting chart	116
Threaded fasteners	117
Engine	119
Fuel.....	120
Engine oil	120
Clutch	121
Transmission	121
Rear-wheel drive.....	122
Running gear	122
Brakes	123
Wheels and tyres	123
Electrics	124
Frame	126
Dimensions	126
Weights.....	127

Riding specifications	127
-----------------------------	-----

troubleshooting chart

Engine does not start at all or is difficult to start.

Possible cause

Rectification

Emergency off switch (kill switch)	Kill switch in operating position (run).
Side stand	Retract the side stand (➡ 56).
Gear engaged and clutch not disengaged.	Select neutral or pull the clutch lever (➡ 56).
Clutch pulled before ignition was switched on	Switch on the ignition, then pull the clutch lever.
No fuel in tank	Refuelling (➡ 62).
Battery flat	Charge the battery when connected (➡ 108).

Threaded fasteners

Front wheel	Value	Valid
Brake caliper on fork leg		
M10 x 1.25 x 35 - 10.9	30 Nm	
Clamp of quick-release axle		
M8 x 40	20 Nm	
Quick-release axle in fork leg		
M24 x 1.5	50 Nm	
Rear wheel	Value	Valid
Locknut of the final-drive chain tensioning screw		
M8	19 Nm	
Rear quick-release axle in swinging arm		
M16 x 1.5	100 Nm	

Mirrors**Value****Valid**

Locknut (mirror) to clamp adapter		
M14 x 1	20 Nm	

Engine

10

119

Technical data

Engine design	Two-cylinder four-stroke, DOHC with chain-and-sprocket drive, 4 valves operated by cam followers, balancing conrod, liquid-cooled cylinders and heads, integral water pump, 6-speed gearbox and dry sump lubrication
Displacement	798 cm ³
Cylinder bore	82 mm
Piston stroke	75.6 mm
Compression ratio	12 : 1
Nominal output	64 kW, - at engine speed: 8000 min ⁻¹
- with power reduction ^{OE}	25 kW, - at engine speed: 6000 min ⁻¹
Torque	86 Nm, - at engine speed: 6000 min ⁻¹
- with power reduction ^{OE}	58 Nm, - at engine speed: 3250 min ⁻¹
Maximum engine speed	max 9000 min ⁻¹
Idle speed	1250 ⁺⁵⁰ min ⁻¹

Fuel

Recommended fuel grade	Super unleaded 95 ROZ/RON 89 AKI
Usable fuel capacity	approx. 16 l
Reserve fuel	approx. 2 l

BMW recommends BP fuels 

Engine oil

Engine oil, capacity	3 l, with filter change
products recommended by BMW Motorrad and generally admissible viscosity classes	
Castrol GPS SAE 10W-40, API SG / JASO MA	≥ -20 °C
SAE 10W-40, API SF / SG / SH	≥ -20 °C, Operation in winter
SAE 15W-40, API SF / SG / SH	≥ -10 °C

BMW recommends 

Oil additives

BMW Motorrad recommends not using oil additives, because they can have a detrimental effect on clutch operation. Please do not hesitate to contact your authorised BMW Motorrad dealer if you have any questions relating the choice of a suitable engine oil for your motorcycle.

BMW recommends 

Clutch

clutch type

Multiplate clutch running in oil bath

Transmission

gearbox type

Claw-shift 6-speed gearbox, integrated into engine block

Gearbox transmission ratios

1.943 (35/68 teeth), Primary transmission ratio
 1:2.462 (13/32 teeth), 1st gear
 1:1.750 (16/28 teeth), 2nd gear
 1:1.381 (21/29 teeth), 3rd gear
 1:1.227 (22/27 teeth), 4th gear
 1:1.130 (23/26 teeth), 5th gear
 1:1.042 (24/25 teeth), 6th gear

Rear-wheel drive

Type of final drive	Chain drive
Type of rear suspension	Two-arm cast-aluminium swinging arm
Number of teeth, rear-wheel drive (Pinion / sprocket)	20 / 47

Running gear

Front wheel

Type of front suspension	Telescopic forks
Spring travel, front	125 mm, At wheel

Rear wheel

Type of rear suspension	Two-arm cast-aluminium swinging arm
Type of rear suspension	Direct-pivot central spring strut with steplessly adjustable rebound-stage damping
Spring travel at rear wheel	125 mm

Brakes

Front wheel

Type of front brake	Hydraulically operated twin disc brake with 4-piston fixed calipers and floating brake discs
Brake-pad material, front	Sintered metal

Rear wheel

Type of rear brake	Hydraulically operated disc brake with 1-piston floating caliper and fixed disc
Brake-pad material, rear	sintered metal

Wheels and tyres

Recommended tyre sets	You can obtain an up-to-date list of approved tyres from your authorised BMW Motorrad dealer or on the Internet at " www.bmw-motorrad.com ".
-----------------------	--

Front wheel

front wheel type	Cast aluminium, MT H2
front wheel rim size	3.50" x 17"
Tyre designation, front	120 / 70 ZR 17

Rear wheel

rear-wheel type	Cast aluminium, MT H2
rear wheel rim size	5.5" x 17"
Tyre designation, rear	180 / 55 ZR 17

Tyre pressures

Tyre pressure, front	2.5 bar, Tyre cold
Tyre pressure, rear	2.9 bar, Tyre cold

Electrics

Electrical rating of on-board socket	5 A, One on-board socket
Fuses	Electronic fuses protect the circuits. If an electronic fuse trips and de-energises a circuit, the circuit is active as soon as the ignition is switched on after the fault has been rectified.

Battery

battery type	AGM (Absorbent Glass Mat) battery
battery rated voltage	12 V
battery rated capacity	14 Ah

Spark plugs

Spark plugs, manufacturer and designation	NGK DCPR 8 E
Electrode gap of spark plug	0.8...0.9 mm, When new

Lighting

Bulb for high-beam headlight	H7 / 12 V / 55 W
Bulbs for the low-beam headlight	H7 / 12 V / 55 W
Bulb for parking light	W5W / 12 V / 5 W
Bulb for tail light/brake light	P21/5W / 12 V / 5 W / 21 W
Bulbs for flashing turn indicators, front	R10W / 12 V / 10 W
– with white turn indicators ^{OE}	RY10W / 12 V / 10 W
– with LED turn indicators ^{OE}	LED / 12 V
Bulbs for flashing turn indicators, rear	R10W / 12 V / 10 W
– with white turn indicators ^{OE}	RY10W / 12 V / 10 W
– with LED turn indicators ^{OE}	LED / 12 V

Frame

Frame type	Light alloy weldment with bolt-on tubular steel rear frame
type plate location	Steering head, right
VIN location	Steering head, right

Dimensions

Length of motorcycle	2082 mm
Height of motorcycle	1240 mm, without rider at DIN unladen weight
Width of motorcycle	812 mm, across mirrors without mirrors
Front-seat height	800 mm, Without rider at unladen weight
– with dual seat, low ^{OE}	770 mm, Without rider at unladen weight
– with high seat	820 mm, Without rider at unladen weight
rider's inside-leg arc, heel to heel	1790 mm, Without rider at unladen weight
– with dual seat, low ^{OE}	1750 mm, Without rider at unladen weight
– with high seat	1830 mm, Without rider at unladen weight

10

127**Technical data**

Weights

Unladen weight	199 kg, DIN unladen weight, ready for road, 90 % load of fuel, without optional extras
Permissible gross weight	405 kg
Maximum payload	201 kg

Riding specifications

Top speed	>200 km/h
– with power reduction ^{OE}	155 km/h

Technical data

10

128

Service

BMW Motorrad service	130
BMW Motorrad service quality	130
BMW Motorrad mobility services - roadside assistance	130
BMW Motorrad service network	131
Maintenance work	131
Confirmation of maintenance work	132
Confirmation of service	137

BMW Motorrad service

Advanced technology requires specially adapted methods of maintenance and repair.



If maintenance and repair work is performed inexpertly, it could result in consequential damage and thus constitute a safety risk.

BMW Motorrad recommends you to have all the associated work on your motorcycle carried out by a specialist workshop, preferably an authorised BMW Motorrad dealer. ◀

Your authorised BMW Motorrad dealer can provide information on BMW services and the work undertaken as part of each service. Have all maintenance and repair work carried out confirmed in the "Service" chapter in this manual. Authorised BMW Motorrad dealers are supplied with the latest technical information and have

the necessary technical know-how. BMW Motorrad recommends that you contact your authorised BMW Motorrad dealer if you have questions regarding your motorcycle.

BMW Motorrad service quality

Along with its reputation for engineering quality and high reliability, BMW Motorrad is a byword for excellent quality of service.

To ensure that your BMW is always in optimum condition, BMW Motorrad recommends that you have the maintenance work required for your motorcycle carried out regularly, preferably by your authorised BMW Motorrad dealer. For generous treatment of claims submitted after the warranty period has expired, evidence of regular maintenance is essential.

Certain signs of wear, moreover, may otherwise not be noticed until it is too late to put them right at moderate cost. Your authorised BMW Motorrad dealer's mechanics know every detail of your motorcycle and can take remedial action if necessary before minor faults develop into serious problems. By having the necessary repairs done properly and in good time, you save time and money in the long run.

BMW Motorrad mobility services - roadside assistance

In the event of a breakdown, the BMW Motorrad mobility services available for each new BMW motorcycle enable you to access an extensive range of services such as breakdown assistance, motorcycle transportation etc. (details can differ from country to country). In the event of a breakdown,

contact the Mobile Service organisation of BMW Motorrad. The specialists will provide the necessary advice and assistance. You will find important country-specific contact addresses and the after-sales service organisation phone numbers in the "Service Kontakt / Service Contact" brochures, along with information on Mobile Service and the dealership network.

BMW Motorrad service network

BMW Motorrad has an extensive after-sales service network in place to look after you and your motorcycle in more than 100 countries. In Germany alone, you have the best possible access to approximately 200 authorised BMW Motorrad dealers. All information concerning the international dealership network can be found in the brochure

"Service Contact Europe" or "Service Contact Africa, America, Asia, Australia, Oceania".

Maintenance work

BMW Pre-delivery Check

Your authorised BMW Motorrad dealer conducts the BMW pre-delivery check before handing over the motorcycle to you.

BMW Running-in Check

The BMW running-in check has to be performed when the motorcycle has covered between 500 km and 1500 km.◀

BMW Service

The BMW Service is carried out once a year; the extent of servicing can vary, depending on the age of the motorcycle and the distance it has covered. Your authorised BMW Motorrad dealer confirms that the service work has been carried out and enters

the date when the next service will be due.

Riders who cover long distances in a year might have to bring in their motorcycles for service before the next scheduled date. It is to allow for these cases that a maximum odometer reading is entered as well in the confirmation of service. Servicing has to be brought forward if this odometer reading is reached before the next scheduled date for the service.

The service-due indicator in the multifunction display reminds you about one month or 1000 km in advance when the time for a service is approaching, on the basis of the programmed values.◀

Confirmation of maintenance work**BMW Pre-delivery
Check**

Completed

on _____

Stamp, signature**BMW Running-in
Check**

Completed

on _____

Odometer reading _____

Next service
at the latest

on _____

or, if logged beforehand,

Odometer reading _____

Stamp, signature

BMW Service

Completed

on _____

Odometer reading _____

Next service
at the latest

on _____

or, if logged beforehand,

Odometer reading _____

Stamp, signature**BMW Service**

Completed

on _____

Odometer reading _____

Next service
at the latest

on _____

or, if logged beforehand,

Odometer reading _____

Stamp, signature**BMW Service**

Completed

on _____

Odometer reading _____

Next service
at the latest

on _____

or, if logged beforehand,

Odometer reading _____

Stamp, signature**11**

133

Service

BMW Service

Completed

on _____

Odometer reading _____

Next service
at the latest

on _____

or, if logged beforehand,

Odometer reading _____

Stamp, signature**BMW Service**

Completed

on _____

Odometer reading _____

Next service
at the latest

on _____

or, if logged beforehand,

Odometer reading _____

Stamp, signature**BMW Service**

Completed

on _____

Odometer reading _____

Next service
at the latest

on _____

or, if logged beforehand,

Odometer reading _____

Stamp, signature

BMW Service

Completed

on _____

Odometer reading _____

Next service
at the latest

on _____

or, if logged beforehand,

Odometer reading _____

Stamp, signature**BMW Service**

Completed

on _____

Odometer reading _____

Next service
at the latest

on _____

or, if logged beforehand,

Odometer reading _____

Stamp, signature**BMW Service**

Completed

on _____

Odometer reading _____

Next service
at the latest

on _____

or, if logged beforehand,

Odometer reading _____

Stamp, signature**11**
135**Service**

BMW Service

Completed

on _____

Odometer reading _____

Next service
at the latest

on _____

or, if logged beforehand,

Odometer reading _____

Stamp, signature**BMW Service**

Completed

on _____

Odometer reading _____

Next service
at the latest

on _____

or, if logged beforehand,

Odometer reading _____

Stamp, signature**BMW Service**

Completed

on _____

Odometer reading _____

Next service
at the latest

on _____

or, if logged beforehand,

Odometer reading _____

Stamp, signature

Confirmation of service

The table is intended as a record of maintenance and repair work, the installation of optional accessories and, if appropriate, special campaign (recall) work.

Item	Odometer reading	Date

A
Abbreviations and symbols, 6
ABS
 Engineering details, 66
 Self-diagnosis, 58
 Warnings, 33
Accessories
 General instructions, 72
Anti-theft alarm
 Telltale light, 18
 Warnings, 32

B
Battery
 Charging battery when connected, 108
 Charging battery when disconnected, 109
 Installation, 110
 Maintenance instructions, 107
 Position on the motorcycle, 15
 Removal, 109
 Technical data, 124

Brake fluid
 Checking fluid level, front, 85
 Checking fluid level, rear, 86
 Reservoir, front, 13
 Reservoir, rear, 13
Brake pads
 Checking front, 83
 Checking rear, 84
 Running in, 59
Brakes
 Adjusting handlebar lever, 46
 Checking operation, 82
 Safety instructions, 60
 Technical data, 123
Bulbs
 General instructions, 98
 Replacing high-beam headlight bulb, 99
 Replacing low-beam headlight bulb, 99
 Replacing side-light bulb, 100
 Replacing the brake light and rear light bulbs, 102
 Replacing turn indicator bulbs, 103

 Technical data, 125
 Warning for bulb failure, 31

C
Case
 Operation, 73
Chain
 Adjusting sag, 90
 Checking sag, 89
 Checking wear, 90
 Lubricating, 89
Checklist, 56
Clock
 Adjusting, 39
 Control, 18
Clutch
 Adjusting handlebar lever, 46
 Adjusting play, 88
 Checking operation, 87
 Checking play, 88
 Technical data, 121
Confirmation of maintenance work, 132

Coolant
 Checking fill level, 87
 Fill-level indicator, 13
 Topping up, 87
 Warning for
 overtemperature, 30

Currency, 7

D

Damping
 Adjuster, 13
 Adjusting, 49

Dimensions
 Technical data, 126

E

Electrics
 Technical data, 124

Emergency off switch (kill
 switch), 17
 Operation, 45

Engine
 Control, 17
 Starting, 56
 Technical data, 119
 Warning for engine
 electronics, 31

Engine oil
 Checking fill level, 81
 Filler neck, 11
 Oil dipstick, 11
 Technical data, 120
 Topping up, 82
 Warning for engine oil
 pressure, 31

Equipment, 7

F

First-aid kit
 Stowage, 14

Frame
 Technical data, 126

Front-wheel stand
 Installing, 97

Fuel
 Filler neck, 13
 Fill-level indicator, 23
 Refuelling, 62
 Technical data, 120
 Warning for fuel down to
 reserve, 30

Fuses

 Technical data, 124

G

General views
 Instrument panel, 18
 Left handlebar fitting, 16
 Left side of motorcycle, 11
 Multifunction display, 22
 Right handlebar fitting, 17
 Right side of motorcycle, 13
 Underneath the seat, 14
 Underneath the trim panel, 15
 Warning and telltale lights, 24

Grip heating
 Control, 17
 Operation, 45

H
Handlebar fittings
 General view, left side, 16
 General view, right side, 17
Hazard warning flashers
 Control, 16
 Operation, 44
Headlight
 Adjusting headlight beam
 throw, 50
 Adjustment for driving on left/
 driving on right, 50
 Beam throw, 50
Horn, 16

I
Ignition
 Switching off, 38
 Switching on, 38
Immobiliser
 Reserve key, 39
 Warning, 30
Instrument panel
 Ambient-light brightness
 sensor, 18
 Overview, 18

J
Jump starting, 106

K
Keys, 38

L
Lights
 Control, 16
 Headlight flasher, operating, 43
 High-beam headlight,
 operating, 43
 Low-beam headlight, 43
 Parking lights, operating, 43
 Side light, 43
Luggage
 Instructions for loading, 54
 lashing, 73

M
Maintenance
 General instructions, 80
Maintenance intervals, 131
Mirrors
 Adjusting, 47
Mobility services, 130

Motorcycle
 care, 111
 Cleaning, 111
 Laying up, 114
 Parking, 61
 Restoring to use, 114
Multifunction display, 18
 Overview, 22
 Select the readings, 40

O
Odometer and tripmeters
 Control, 18
On-board computer
 Control, 16
 Warnings, 32

P
Parking, 61
Power socket
 Notes on use, 72
 Position on the motorcycle, 13
Pre-ride check, 57

R
Rear-wheel drive
 Technical data, 122
Redline warning
 Indicator, 18
 Switching on, 59
Refuelling, 62
Reserve volume
 Warning, 30
Rev. counter, 18
Rider's Manual
 Position on the motorcycle, 14
Running gear
 Technical data, 122
Running in, 58

S
Safety instructions
 for brake, 60
 for riding, 54
Seat
 Installation, 51
 Lock, 11
 Removal, 51

Service, 130
Service toolkit
 Stowage, 14
Service-due indicator, 25
Spark plugs
 Technical data, 125
Speedometer, 18
Spring preload
 Adjuster, 13
 Adjusting, 48
 Tools, 14
Starting
 Control, 17
Steering lock, 38
Stopwatch
 Operation, 41

T
Technical data
 Battery, 124
 Brakes, 123
 Bulbs, 125
 Clutch, 121
 Dimensions, 126
 Electrics, 124

Engine, 119
Engine oil, 120
Frame, 126
Fuel, 120
Rear-wheel drive, 122
Running gear, 122
Spark plugs, 125
Standards, 7
Transmission, 121
Weights, 127
Wheels and tyres, 123
Telltale lights, 18
 Overview, 24
Toolkit
 Contents, 80
 Position on the motorcycle, 14
topcase
 Operation, 76
Torques, 117
Transmission
 Technical data, 121
Transportation
 Lashing, 63

- Trim panels
 - Installing centre trim panel, 105
 - Removing centre trim panel, 104
- troubleshooting chart, 116
- Turn indicators
 - Control, 16
 - Operation, 44
- Type plate
 - Position on the motorcycle, 13
- Tyre pressure monitoring RDC
 - Adhesive label for rim, 91
 - Engineering details, 68
 - Warnings, 33
- Tyre repair kit
 - Stowage, 15
- Tyres
 - Checking inflation pressure, 49
 - Checking tread depth, 89
 - Pressures, 124
 - Recommendation, 91
 - Running in, 59
 - Table of tyre pressures, 14
 - Technical data, 123
- V**
 - Vehicle identification number
 - Position on the motorcycle, 13
- W**
 - Warning lights, 18
 - Overview, 24
 - Warnings
 - Mode of presentation, 27
 - With ABS, 33
 - With anti-theft alarm, 32
 - With on-board computer, 32
 - With RDC, 33
 - Warnings, overview, 28
 - Weights
 - Payload table, 11
 - Technical data, 127
 - Wheels
 - Change of size, 91
 - Checking rims, 88
 - Installing front wheel, 93
 - Installing rear wheel, 96
 - Remove the rear wheel, 95
 - Removing front wheel, 92
 - Technical data, 123